



Iridium **Extreme**[™]

User Manual



Iridium **Extreme™** User Manual

web: www.iridium.com

email: info@iridium.com

toll free: +1.866.947.4348

phone: +1.480.752.5155

Legal Notices

This User Manual provides user information and is provided “as is.” Iridium and its affiliated companies, directors, officers, employees, agents, trustees or consultants (“Iridium”) assume no responsibility for any typographical, technical, content or other inaccuracies in this User Manual. Iridium reserves the right to revise this User Manual or withdraw it at any time without prior notice. You can find the current version of this Iridium Extreme™ User Guide at www.iridiumextreme.com.

IRIDIUM MAKES NO REPRESENTATIONS, GUARANTEES, CONDITIONS OR WARRANTIES, EITHER EXPRESS OR IMPLIED, INCLUDING WITHOUT LIMITATION, ANY IMPLIED REPRESENTATIONS, GUARANTEES, CONDITIONS OR WARRANTIES OF MERCHANTABILITY AND FITNESS FOR A PARTICULAR PURPOSE, NON-INFRINGEMENT, SATISFACTORY QUALITY, NON-INTERFERENCE, ACCURACY OF INFORMATIONAL CONTENT, OR ARISING FROM A COURSE OF DEALING, LAW, USAGE, OR TRADE PRACTICE, USE, OR RELATED TO THE PERFORMANCE OR NONPERFORMANCE OF ANY PRODUCTS, ACCESSORIES, FACILITIES, SERVICES OR USER INFORMATION, EXCEPT AS EXPRESSLY STATED IN THIS USER MANUAL. ANY OTHER STANDARDS OF PERFORMANCE, GUARANTEES, CONDITIONS AND WARRANTIES ARE HEREBY EXPRESSLY EXCLUDED AND DISCLAIMED TO THE FULLEST EXTENT PERMITTED BY LAW. THIS DISCLAIMER AND EXCLUSION SHALL APPLY EVEN IF THE EXPRESS LIMITED WARRANTY CONTAINED IN THIS USER MANUAL FAILS OF ITS ESSENTIAL PURPOSE. FURTHER, THIS LIMITED WARRANTY COVERS THE Iridium Extreme™ (INCLUDING HARDWARE, SOFTWARE AND/OR FIRMWARE, BUT EXCLUDING LEATHER CASE) AND ACCESSORIES ONLY, AND NO WARRANTY IS MADE AS TO USER INFORMATION AND/OR COVERAGE, AVAILABILITY OR GRADE OF SERVICE PROVIDED BY IRIDIUM SEPARATELY FOR IRIDIUM SATELLITE SERVICES.

IN NO EVENT SHALL IRIDIUM BE LIABLE, WHETHER IN CONTRACT OR TORT OR ANY OTHER LEGAL THEORY, INCLUDING WITHOUT LIMITATION STRICT LIABILITY, GROSS NEGLIGENCE OR NEGLIGENCE, FOR ANY DAMAGES IN EXCESS OF THE PURCHASE PRICE OF THE Iridium Extreme™ (INCLUDING HARDWARE, SOFTWARE AND/OR FIRMWARE) AND/OR ACCESSORIES AND/OR THE COST OF IRIDIUM SATELLITE SERVICES PROVIDED, INCLUDING ANY DIRECT, INDIRECT, INCIDENTAL, SPECIAL OR CONSEQUENTIAL DAMAGES OF ANY KIND, OR LOSS OF REVENUE OR PROFITS, LOSS OF BUSINESS, LOSS OF PRIVACY, LOSS OF USE, LOSS OF TIME OR INCONVENIENCE, LOSS OF INFORMATION OR DATA, SOFTWARE OR APPLICATIONS OR OTHER FINANCIAL LOSS CAUSED BY THE Iridium Extreme™ (INCLUDING HARDWARE, SOFTWARE AND/OR FIRMWARE) AND/OR ACCESSORIES AND/OR THE IRIDIUM SATELLITE SERVICES, OR ARISING OUT OF OR IN CONNECTION WITH THE ABILITY OR INABILITY TO USE THE Iridium Extreme™ (INCLUDING HARDWARE, SOFTWARE AND/OR FIRMWARE) AND/OR ACCESSORIES AND/OR THE IRIDIUM SATELLITE SERVICES TO THE FULLEST EXTENT THESE DAMAGES MAY BE DISCLAIMED BY LAW AND WHETHER ADVISED OF THE POSSIBILITIES OF SUCH DAMAGES.

Please refer to Chapter 18 of this User Manual for Limited Warranty, Product and Satellite Service Terms and Warranty Support, Conditions of Use and Software License.

Third Party Information

This User Manual might refer to third party sources of information, hardware or software, products or services and/or third party web sites (“third party information”). Iridium does not control, and is not responsible for, any third party information, including without limitation the content, accuracy, copyright compliance, compatibility, performance, trustworthiness, legality, decency, links, or any other aspect of third party information. The inclusion of such third party information does not imply endorsement by Iridium of the third party information. ANY THIRD PARTY INFORMATION THAT IS PROVIDED WITH IRIDIUM'S FACILITIES, SERVICES, PRODUCTS OR USER INFORMATION IS PROVIDED “AS IS.” IRIDIUM MAKES NO REPRESENTATIONS, GUARANTEES OR WARRANTIES IN RELATION TO THIRD PARTY INFORMATION AND IRIDIUM SHALL NOT BE LIABLE FOR ANY LOSSES, DAMAGES, LIABILITIES, JUDGMENTS, FINES, AMOUNTS PAID IN SETTLEMENT, EXPENSES OR COSTS OF DEFENSE SUSTAINED IN RELATION TO ANY SUCH THIRD PARTY INFORMATION.

Intellectual Property, Trade Secret, Proprietary or Copyrighted Information

To protect Iridium proprietary and confidential information and/or trade secrets, this User Manual may describe some aspects of Iridium technology in generalized terms. Iridium products may include copyrighted Iridium and third party software. Any such copyrighted software contained in Iridium products may not be modified, reverse engineered, distributed or reproduced in any manner to the extent provided by law. The purchase of any Iridium products shall not be deemed to grant either directly or by implication or otherwise, any license under copyrights, patents, or patent applications of Iridium or any third party software provider, except for the normal, nonexclusive, royalty free license to use that arises by operation of law in the sale of a product. Please refer to Chapter 18 of this User Manual for Limited Warranty, Product and Satellite Service Terms and Warranty Support, Conditions of Use and Software License.

Content Copyright

You are exclusively responsible for the use of the Iridium Extreme™, including proper use of third party copyrighted materials. If you violate these terms you agree to defend, indemnify and hold Iridium harmless with respect to any claims or actions by third parties related to your improper use of copyrighted materials and to pay all costs, damages, fines and other amounts incurred by Iridium, or on its behalf, in the defense of any such claims or actions.

Contents

1: Introduction	1
Related Documents	1
2: Important Safety Information	3
Safety and Warning Icons	3
Exposure to Radio Frequency Signals	4
Specific Absorption Rate Data	4
Batteries	6
Battery Charging	7
Battery Disposal	7
Emergency Calling	7
Antenna Care	8
Driving and Operation of Other Motor Vehicles	9
Posted Facilities	9
Blasting Areas	9
Potential Explosive Atmospheres	9
Electronic Devices	9
Product Operation	10
Radio Interference	10
Implantable Medical Devices	11
Persons with pacemakers:	11
Hearing Aids	11
Other Medical Devices	11
Aircraft	11
Vehicles	12
Vehicles Equipped with an Air Bag	12
Adult Use Only	12
Glass Parts	12
Extended Exposure to Loud Noise	12
Seizures and Blackouts	12
Repetitive Motion	13
3: Iridium Extreme™ Overview	15
Guide Overview	15
Phone Overview	16
Front View	16
Side View	17
Back View	18
Charging / USB / External Antenna Adapters	19
Adapter #1: Charging / USB	19

Adapter #2: Charging / USB / External Antenna	19
Installation of the adapter	20
Use of the adapter	20
Removal of the adapter	21
Accessories.....	21
AC Travel Charger and International Plug Kit	21
Headset	22
Auto Accessory Charger	23
External Antenna	23
Leather Case	24
USB Data Cable.....	25
Indicators.....	26
Status Indicator LED.....	26
Display Status Indicators and Icons	27
Main Screen Components.....	27
Menu Components	28
4: Getting Started	29
Using the SIM Card.....	29
SIM Card Care	29
Insert the SIM Card.....	30
Remove the SIM Card.....	30
Battery Pack Information	31
Battery Charging.....	32
Battery Disposal	32
Remove and Install the Battery Pack.....	33
To Remove the Battery Pack	33
To Install the Battery Pack.....	34
Charging the Battery	35
Charge the Battery Pack.....	35
Checking Battery Charge Level	35
Low Battery Warning	35
Start-up Procedure.....	36
Power on Message	36
Phone Operation	38
Normal Operation.....	38
Tips on Efficient Operation.....	38
Placing a Call	39
Before you place a call:	39
Dial the Number.....	39
End a Call	41
Re-dial Last Number Called	42

Receiving a Call	42
Before you receive a call:.....	42
Receiving a call with the Antenna Extended.....	43
Answering the call with the Antenna Extended.....	44
Receiving a Call with the Antenna Stowed	45
Muting a Call	47
Speaker Phone.....	47
Speaker Volume	47
Ringer Volume	48
Unanswered Calls	49
Messages from Missed Calls	49
Locking and Unlocking the Keypad.....	50
Unlocking the Keypad	51
5: Using Menus and Keys.....	53
Using the Keys	53
The Soft Keys	53
The 2-way Navi-key	53
The Keypad	54
Using the Menus.....	54
To Access the Main Menu	54
To Access Main Menu Options.....	55
To Return to a Menu	56
Entering Characters.....	56
6: Traditional Text Entry	59
Entering Characters	59
Keypad Guide.....	60
Available Characters	60
Entering Punctuation	61
Entering Numbers and Symbols into Text	62
7: Predictive Text Entry	65
LetterWise Text mode.....	68
WordWise Text mode.....	70
Digit mode (123)	72
Punctuation mode (#?@).....	72
8: Using the Phonebooks	75
Organizing My Phonebook.....	75
Phone Memory.....	75
SIM Card Memory	75
Personal Numbers.....	75

Fixed Dial Numbers.....	75
Name Characters	75
Locating My Phonebook.....	75
About the My Phonebook Menu	76
Add a New Entry to My Phonebook	77
Locating Entries.....	79
Calling an Entry	80
Using the Short Message Service (SMS) Menu	82
Edit an Entry in My Phonebook.....	85
Delete an Entry.....	87
Viewing Memory Status.....	89
Adding Notes to a Phonebook Entry.....	90
Restricted Phonebook	91
9: Using the Messages Menu	93
Locating the Messages Menu	93
Create and Send a new SMS Message to an Email Address not in your Phonebook	94
Create and Send a new SMS Message to an Email Address in My Phonebook	96
About SMS Messaging.....	98
Message Notification.....	98
How Messages are Stored	98
What Messages Contain	98
Using the Inbox Menu	99
Read a Message.....	99
Reply to Sender	100
Forward a Received Message	101
Call a Number from a Received Message.....	104
Delete a Message.....	104
Using the Drafts Menu.....	106
Using the Settings Menu	109
Enter Service Center Number.....	109
Set Expiry Period	110
Select Delivery Reports	112
10: Using the Voicemail Menu	113
Locating the Voicemail Menu	113
About the Voicemail Menu	113
Voicemail Notification.....	114
Check Your Voicemail	114
Store Your Voicemail Number	115

One-Touch Access to Voicemail.....	116
11: Using the Data Modem Menu	117
Locating the Data Modem Menu.....	117
12: Using the Call History Menu	119
Locating the Call History Menu	119
About the Call History Menu.....	119
Using the Call Log Menu.....	120
View Most Recent Received Calls.....	120
View Missed Calls.....	121
View Most Recent Dialed Calls	122
Using the Call Meters Menu.....	124
Show the Time of Last Call.....	124
Show Total Time for All Calls	125
Reset all Timers	126
Showing the Lifetime Call Timer	128
Showing the In-call Display	129
Setting Audible Call Timers.....	131
Set the Single Alert Timer	131
Set the Repetitive Alert.....	133
13: Using the Setup Menu	135
Locating the Setup Menu	135
About the Setup Menu.....	135
Setting Call Options.....	136
Setting Volumes and Tones.....	137
Adjust the Ringer Volume.....	137
Adjust the Speaker Volume.....	139
Adjust the Ring Tone	140
Setting the Call Alert Mode.....	142
Setting the Keypad Tone.....	143
Set the Phone to Ring and /or Vibrate	145
Time and Date Settings	146
Select the Time Zone.....	146
Select the Time Format.....	148
Select the Date Format	149
Selecting the Display Language	150
Setting Backlights.....	152
Setting Contrast	153
Using the Key Setup Menu.....	154
Setup the Convenience Key Function.....	154
Setup the Right Soft Key Function	155

Set Number Entry Prefix.....	156
View Phone Information	157
Reset Phone Options to Factory Defaults	158
14: GPS and Location-Based Services	161
Location Options Setup Menu	161
Locating Location Options.....	162
Using the GPS Options Menu.....	163
GPS Settings Lock.....	163
GPS Update Options.....	164
Turning GPS On/Off	165
Setting Emergency Options	165
Emergency Mode	166
Emergency Actions.....	168
Emergency Beep.....	169
Message Recipient	169
Call Recipient	171
Message Options	172
GPS Quick List	174
Format	174
Position Format	175
Altitude Format	175
Current Location.....	176
Online Portal Integration with 3 rd Parties	177
15: Using the Security Menu	179
Locating the Security Menu.....	179
About the Security Menu	180
Locking and Unlocking Your Phone	180
Enable or Disable the SIM lock	181
Using the Change PIN Menu	183
Change the Phone PIN Code	183
Change the SIM PIN Code.....	185
Change the SIM Card PIN2 Code.....	187
Call Barring PIN	189
16: Troubleshooting	191
17: Certification and Compliance Information.....	195
Export Compliance	195
Standards Compliance Information.....	195

FCC Compliance 195
EU Regulatory Conformity..... 195
Canada Regulatory Conformity..... 195

18: Limited Warranty, Product and Satellite Service Terms, Warranty Support, and Software License 197

Exclusions 198
Limitations of Warranty/Local Laws..... 199
Conditions of Use and Limitations of Liability 200
Warranty Claim Process 202
SOFTWARE LICENSE..... 203

1: Introduction

Thank you for purchasing the state of the art Iridium Extreme™.

This User Manual contains the procedures for the safe operation of the satellite phone and the available facilities.

Important: Read this entire manual, including the safety information in Chapter 2 before using the Iridium Extreme™.

Related Documents

The following Iridium product documentation is available to help you:

- Iridium Extreme™ Specification Sheet
- Iridium Extreme™ Quick Start Guide

Refer to www.iridiumextreme.com for your copies.

2: Important Safety Information

Important: Read this entire chapter, before using the Iridium Extreme™.

Safety and Warning Icons

The following conventions are used in this User Manual.



Caution!

Care must be taken. Failure to follow directions carefully could result in damage to equipment.



Warning!

Failure to comply with this warning could result in serious damage to life, limb or property.

Before doing this task, be sure to familiarize yourself with appropriate safety practices, personal protective equipment and have a plan in case of accident.



Do not let your battery, charger, or satellite phone come in contact with water.



Risk of explosion.



High heat source. Burn risk.



Do not dispose in trash.



Do not dispose of your battery in a fire.



Harmful noise.

Exposure to Radio Frequency Signals

Your Iridium Extreme™ is a low power radio transmitter and receiver. When it is ON, it receives and also sends out radio frequency (RF) signals. Your Iridium Extreme™ is designed to comply with local regulatory requirements in your country concerning the exposure of human beings to RF frequency.

International agencies have set standards and recommendations for the protection of public exposure to RF electromagnetic energy.

- International Commission on Non-Ionizing Radiation Protection (ICNIRP)
- Verband Deutscher Elektrotechniker (VDE)
- United States Federal Communications Commission (FCC), Radio Frequency Exposure Guidelines
- National Radiological Protection Board of the United Kingdom
- American National Standards Institute (ANSI) IEEE. C95. 1-1992
- National Council on Radiation Protection and Measurements (NCRP). Report 86
- Department of Health and Welfare Canada. Safety Code 6

The design of your phone complies with these standards when used as described under “Phone Operation” on page 38.

This product is compliant with Industry Canada RSS-102 for RF Exposure.

Refer to “Specific Absorption Rate Data” on pages 4-5.

Specific Absorption Rate Data

This Iridium Extreme™ meets international standards for exposure to radio waves.

Your satellite phone is designed and manufactured not to exceed limits for exposure to radio frequency (RF) energy. These limits are part of comprehensive guidelines and established permitted levels of RF energy for the general population. The guidelines are based on standards that were developed by independent scientific organizations through periodic and thorough evaluation of scientific studies. The guidelines include a substantial safety margin designed to assure the safety of all persons, regardless of age and health.

The exposure standard for mobile phones employs a unit of measurement known as the Specific Absorption Rate, or SAR. Under the guidelines for this model, the SAR limit is 1.6 W/Kg. Tests for SAR were conducted in accordance with the European Committee for Electrotechnical Standardization (CENELEC) and FCC testing procedures using standard operating positions with the phone transmitting at its highest certified power level in all tested frequency bands. Although the SAR is determined at the highest certified power level, the actual SAR of the phone while operating can be below the maximum value. Before a phone model is available for sale to the public, it is tested to confirm compliance with the guidelines. The tests are performed in positions and locations (e.g., at the ear and worn on the body) that conform to a uniform testing methodology determined by an expert standards body.

The highest SAR level recorded from this product was 1.27 W/Kg which was below the uncontrolled (i.e., general population) limit. While there may be differences between the SAR levels of various phones and at various positions, they all meet the governmental requirements.

The International Agency for Research on Cancer (IARC) concluded in May, 2011 that there is limited evidence to suggest a possible link between RF signals and two specific types of cancer. The IARC's conclusion is based on its review of existing studies and information.

The FCC and FDA, however, indicated that there is not sufficient scientific evidence to support a link between wireless device use and cancer and that use of wireless phones according to current regulations is safe.

Reference websites:

- www.fcc.gov/guides/wireless-devices-and-health-concerns
- <http://www.fda.gov/Radiation-EmittingProducts/RadiationEmittingProductsandProcedures/HomeBusinessandEntertainment/CellPhones/ucm116282.htm>

If you wish to reduce your exposure to RF energy, you can limit the amount of time you use the phone and increase the distance between the phone/antenna and your body when you use it. For example, you may

use the phone's speakerphone feature or use with a wired earpiece and microphone to increase distance when you use the phone.

PLEASE NOTE THAT MODIFICATIONS TO THIS PRODUCT MODEL COULD CAUSE DIFFERENCES IN THE SAR VALUE FOR LATER PRODUCTS; IN ALL CASES, PRODUCTS ARE DESIGNED TO BE WITHIN THE GUIDELINES.

Batteries

All batteries may cause serious injury or property damage, particularly if handled improperly or used after damage.

Warning!

Improper treatment or use of batteries may present a danger of fire, explosion, leakage, or other hazard.



Make sure to follow all of the following safety guidelines:

- Do not disassemble, crush, puncture, shred or otherwise attempt to change the form of the battery.
- Do not let the phone or battery come in contact with water. Water can lead to corrosion of the phone's circuits.
- Do not allow the battery to touch metal objects. Contact with metal objects can cause the battery to heat and possibly explode.
- Do not place your battery near a heat source. Excessive heat can damage the phone or battery by causing it to swell, leak or malfunction. Do not dry a wet or damp battery with an appliance or heat source, such as a hair dryer or microwave oven. Do not leave your phone in an automobile or other vehicle with high temperatures.
- Do not drop the battery or the phone because the impact can damage them.
- Do not dispose of batteries in a fire, because they may explode.
- Contact your service provider or Iridium if your phone or battery has been damaged from dropping or high temperatures.



WARNING!



Use of non-Iridium batteries or chargers may present a risk of fire, explosion, leakage or other hazard.



Important

Use only Iridium original products for safety and quality assurance. Iridium's warranty does not cover damage caused by use of non-Iridium batteries.

Battery Charging

Batteries may be charged and discharged many times, but eventually they wear out.

Important: Follow these guidelines when charging your battery:

- Keep the battery at room temperature. Never expose batteries to temperatures below 0°C (32°F) or above 45°C (113°F) when charging.
- New batteries are not fully charged and may take more time to charge.

Battery Disposal

Proper battery disposal is not only important for safety but also benefits the environment. Consumers should recycle used batteries and telephones in accordance with applicable national, state or local laws and regulations.



Under EU requirements, all electrical and electronic products must be taken to separate collection at the end of their working life and must not be disposed of as unsorted municipal waste.

Do not dispose of your battery in a fire.



Emergency Calling

CHECK WITH YOUR SERVICE PROVIDER FOR LOCAL EMERGENCY NUMBERS (full international access code, country code, and phone number) for all locations outside the United States and mainland Australia. Iridium currently only supports in-country emergency call routing to 911 within the United States and to Triple Zero (000) or 112 within mainland Australia. Outside of the United States and mainland Australia, calls to emergency access numbers such as 999, are not able to be made on the

Iridium system. When placing a call to an emergency operator or local public safety answering point, always verbally report your location to assist first responders with identifying your location to provide assistance. Caller location identification is not automatically transmitted on the Iridium system.

Iridium does not guarantee network availability at all times due to situations where the network is unavailable due to satellite availability, terrain, weather, or other conditions that may prevent an emergency call from being placed.

EMERGENCY CALLS WITHIN THE UNITED STATES: Power on the Iridium Extreme™, extend the antenna towards the open sky, confirm proper registration & signal strength on the display, dial 911 and press the green send key. Verbally report the situation and your location to the operator for assistance. The Iridium service does not provide enhanced 911 service which automatically identifies the caller location.

EMERGENCY CALLS WITH MAINLAND AUSTRALIA: Power on the Iridium Extreme™, extend the antenna towards the open sky, confirm proper registration & signal strength on display, dial Triple Zero (000) or 112 depending upon your service provider's instructions, and press the green send key. Verbally report the situation and your location to the operator for assistance. The Iridium service does not provide enhanced emergency calling service which automatically identifies the caller location.

EMERGENCY CALLS IN ALL OTHER LOCATIONS: You will need to obtain and dial the full international access code, country code, and phone number for the local fire, police, or ambulance depending upon the nature of the emergency. Power on the Iridium Extreme™, extend the antenna toward the open sky, confirm proper registration & signal strength on the display, dial the local emergency number obtained from your service provider or local advisor and press the green send key. Verbally report the situation and your location to the operator for assistance. The Iridium service does not provide enhanced emergency calling service which automatically identifies the caller location.

Antenna Care

Use only the supplied or an approved replacement antenna. Unauthorized antennas, modifications, or attachments could damage the phone and may violate government regulations. When using remote mount antenna, mount antenna at least 20 cm away from the user. Also when using a remote mount antenna in order to reduce potential radio interference to other users, the antenna type and its gain should be so chosen such that the equivalent isotropically radiated power (EIRP) is not more than that permitted for successful communication.

Driving and Operation of Other Motor Vehicles

The use of any wireless device, including a satellite telephone, may cause distraction. Discontinue a call if you cannot concentrate on driving. Check the laws and regulations on the use of wireless telephones in the areas where you drive. Always obey them. Many local governments prohibit the use of mobile telephones while driving. Observe the following guidelines when using your phone while driving:

- Give full attention to driving—driving safely is your first responsibility.
- Use hands-free phone operation, if available.
- Pull off the road and park safely before making or answering a call.

Posted Facilities

Turn your phone OFF in any facility where posted notices so require.

Blasting Areas

To avoid interfering with blasting operations, turn your phone OFF when in a “blasting area” or in areas posted: “Turn off two-way radio.” Obey all signs and instructions.

Potential Explosive Atmospheres

Areas with a potentially explosive atmosphere are often but not always clearly marked. They include, but are not limited to: fueling areas such as gasoline stations; below deck on boats; fuel or chemical transfer or storage facilities; areas where fuel odors are present (for example, if a gas/propane leak occurs in an automobile or home); areas where the air contains chemicals or particles, such as grain, dust, or metal powders; and any other area where you normally would be advised to turn off your vehicle engine.



Turn your phone OFF and do not remove, install or charge your battery when you are in any area with a potentially explosive atmosphere. Obey all signs and instructions. Sparks from your battery in such areas could cause an explosion or fire resulting in bodily injury or even death.



Electronic Devices

Most electronic equipment is subject to interference from RF energy from external sources if inadequately shielded. In some circumstances your mobile device may cause interference with other devices. Turn off your phone in any location where posted notices instruct you to do so.

For optimal performance and to be sure that exposure to RF energy does not exceed guidelines set forth in the relevant standards discussed in “Exposure to Radio Frequency Signals” on page 4 and “Specific Absorption Rate Data” on page 4 always follow the instructions and precautions.

Product Operation

If you wear the satellite phone on your body, always place it in an Iridium leather case. Refer to www.iridium.com.

Using accessories not supplied by Iridium may cause your satellite phone to exceed RF energy exposure guidelines.

Radio Interference

Your satellite phone contains digital circuits for the display of data and connection to a personal computer. Emissions from these circuits can cause radio interference. With respect to such circuits, this device complies with part 15 of the FCC Rules. Operation is subject to the following two conditions: (1) This device may not cause harmful interference, and (2) this device must accept any interference received, including interference that may cause undesired operation. This statement does not apply to digital circuits used only to enable the operation of the transmitter in this satellite phone. The receiver in this phone is subject to the condition that radio emissions from it not cause harmful interference.

This equipment has been tested and found to comply with the limits for a Class B digital device, pursuant to Part 15 of the FCC Rules. These limits are designed to provide reasonable protection against harmful interference in a residential installation. This equipment generates, uses and can radiate radio frequency energy and, if not installed and used in accordance with the instructions, may cause harmful interference to radio communications. However, there is no guarantee that interference will not occur in a particular installation. If this equipment does cause harmful interference to radio or television reception, which can be determined by turning the equipment off and on, the user is encouraged to try to correct the interference by one or more of the following measures:

- Reorient or relocate the receiving antenna.
- Increase the separation between the equipment and receiver.
- Connect the equipment into an outlet on a circuit different from that to which the receiver is connected.
- Consult the dealer or an experienced radio/TV technician for help.

Implantable Medical Devices

If you have an implantable medical device such as a pacemaker or defibrillator, the Health Industry Manufacturers Association recommends that a minimum separation of six inches (6") be maintained between a handheld wireless phone and a pacemaker to avoid potential interference with the pacemaker. These recommendations are consistent with the independent research by and recommendations of Wireless Technology Research.

Persons with pacemakers:

- should ALWAYS keep the phone more than six inches from their pacemaker when the phone is turned ON.
- should not carry the phone in a breast pocket.
- should use the ear opposite the pacemaker to minimize the potential for interference.
- should turn the phone OFF immediately if there is any reason to suspect that interference is taking place.

Hearing Aids

Some digital wireless phones may interfere with some hearing aids. In the event of such interference, you may want to consult your hearing aid manufacturer to discuss alternatives.

Other Medical Devices

If you use any other personal medical device, consult the manufacturer of your device to determine if it is adequately shielded from external RF energy. Consult your physician to determine compatibility with your medical device.

Turn your phone OFF in health care facilities when any regulations posted in these areas instruct you to do so. Hospitals or health care facilities may be using equipment that could be sensitive to external RF energy.

Aircraft

Airline regulations prohibit using your phone while in the air. Check and comply with the policy of your airline regarding the use of your phone while the aircraft is on the ground.

Switch OFF your phone before boarding an aircraft.

Vehicles

RF signals may affect improperly installed or inadequately shielded electronic systems in motor vehicles. Check with the manufacturer or its representative regarding your vehicle. You should also consult the manufacturer of any equipment that has been added to your vehicle.

Vehicles Equipped with an Air Bag

An air bag inflates with great force. Do NOT place objects, including installed or portable wireless equipment, in the area over the air bag or in the air bag deployment area. If in-vehicle wireless equipment is improperly installed, serious injury could result.

Adult Use Only

Keep your phone and accessories away from children. These products are not toys and may be hazardous to small children. For example:

- A choking hazard may exist for small, detachable parts.
- Improper use could result in loud sounds, causing hearing injury.
- Improperly handled batteries could over heat and cause a burn.

Glass Parts

Some parts of your satellite phone may be made of glass. This glass could break if the product is dropped on a hard surface or receives a substantial impact. If glass breaks do not touch or attempt to remove. Stop using the phone until the glass is replaced by a qualified service center.

Extended Exposure to Loud Noise

Exposure to loud noise from any source for extended periods of time may affect your hearing. The louder the volume sound level, the less exposure is required to affect your hearing. To protect your hearing:



- Limit the amount of time you use headsets or headphones at high volume.
- Avoiding turning up the volume to block out noisy surroundings.
- Turn the volume down if you cannot hear people speaking near you.

Seizures and Blackouts

Some people may be susceptible to epileptic seizures or blackouts when exposed to flashing lights, such as when playing video games. If you or

your family members have a history of such seizures or blackouts, please consult your physician before enabling a flashing lights feature on your phone. Discontinue use or consult a physician if any of the following symptoms occur: convulsion, eye or muscle twitching, loss of awareness, involuntary movements or disorientation.

Repetitive Motion

When you repeatedly perform actions such as pressing keys or entering finger-written characters, you may experience occasional discomfort in your hands, arms, shoulders, neck or other parts of your body. If you continue to have discomfort during or after such use, stop use and see a physician.

3: Iridium Extreme™ Overview

Guide Overview

This chapter provides a complete tour of the Iridium Extreme™. You will discover all the features and components that you need to operate your phone to its full potential.

For ease of use, the chapters in this manual are divided by menu options. Each section of the chapter is then divided by the same sub-menu options as your phone. Just follow the sequence of menus on your phone, the manual will follow along, making the startup process a simple one.



Phone Overview

Front View



Side View

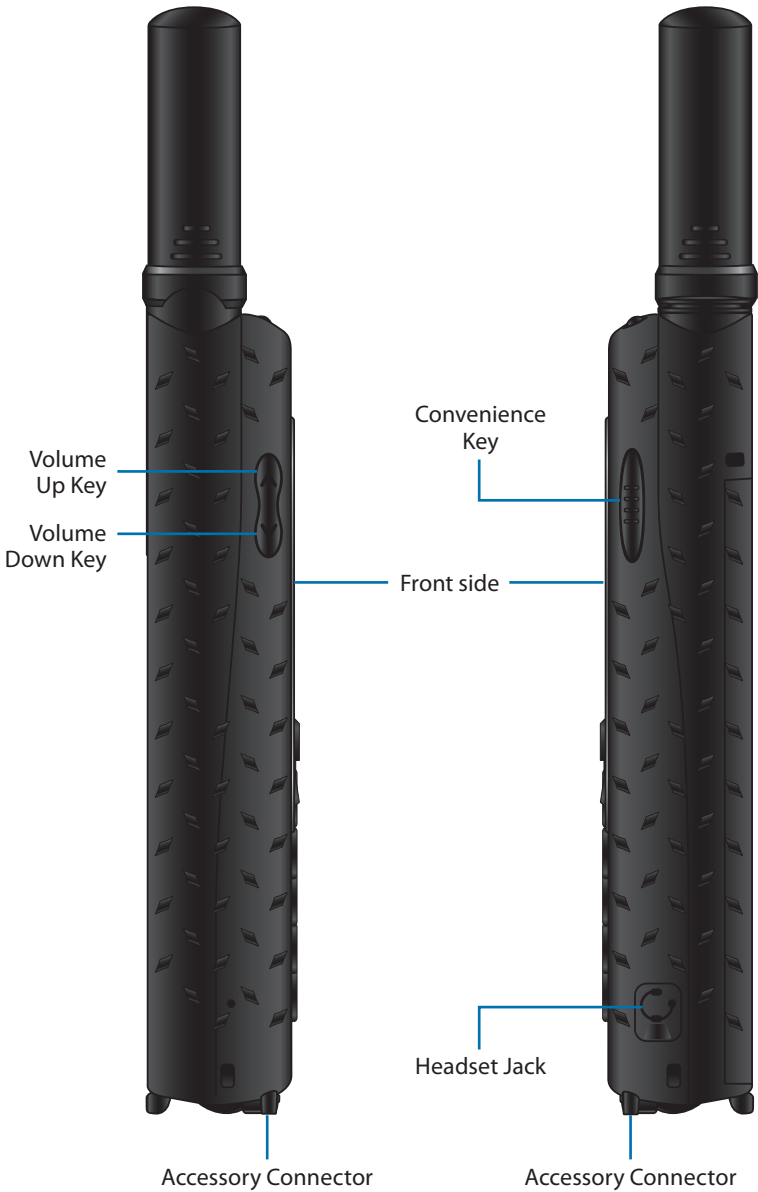

Back View

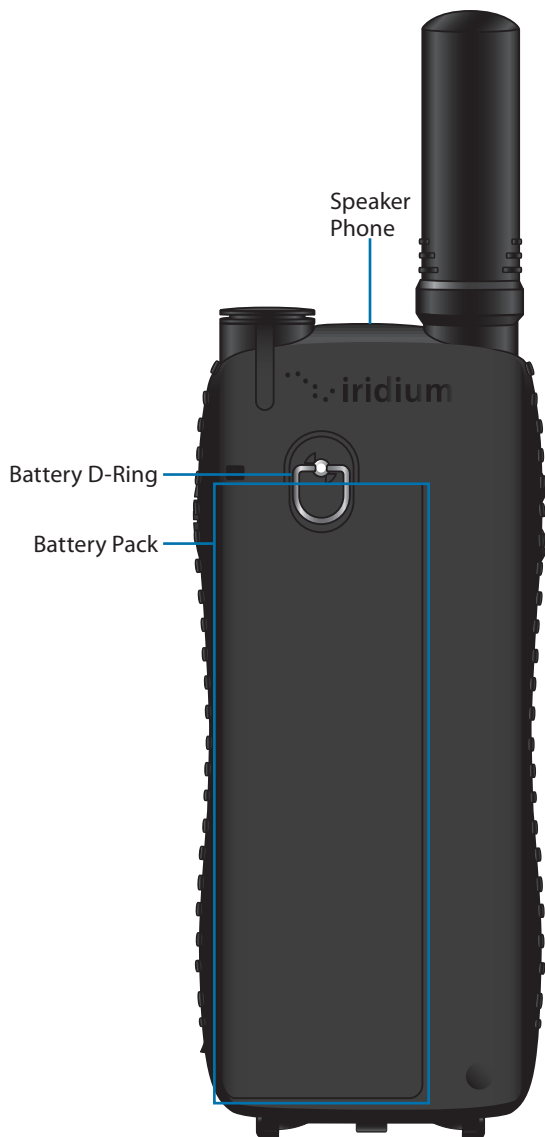

Charging / USB / External Antenna Adapters

Included with the Iridium Extreme™ are two adapters. These adapters attach to the bottom of your phone and are required for charging, connecting the USB data cable, or using the external antenna. These adapters are designed to provide a robust and flexible approach to using external accessories with the Iridium Extreme™.

Adapter #1: Charging / USB



- This adapter is to be used for charging the phone or connecting to a laptop via USB data cable when the phone's antenna is used.

Adapter #2: Charging / USB / External Antenna

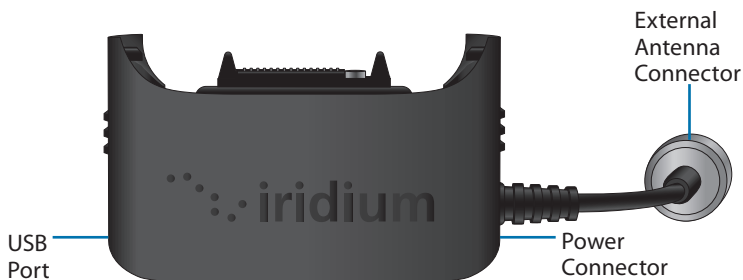

- This adapter is to be used for charging the phone or connecting to a laptop via USB data cable when a wired, external antenna is used. This adapter provides a TNC connector that is compatible with the included 5' external antenna.

Installation of the adapter

- In order to charge, use the USB port, or connect an external antenna, the appropriate adapter must first be selected and attached to the bottom of the phone.
- Prior to installation, open your phone's accessory connector cover on the bottom of your phone and move it to the back of your phone, securing it to the rear retaining features.
- Select the appropriate adapter and orient it with the bottom of the phone so the Iridium brand is facing forward. Then press the adapter up until the side clasps are locked into place and the adapter is securely fastened to your phone.



Use of the adapter

- Once the appropriate adapter is installed on the phone, you may now connect the charging, USB data, or external antenna to your phone.

- Note that the Charging / USB / External Antenna adapter should only be used if you are planning to connect an external antenna. When this adapter is connected, use of your phone's antenna will temporarily be suspended while the Charging / USB External Antenna adapter is connected.

Removal of the adapter

- To remove the adapter, hold your phone with your left hand and grasp the adapter on both sides. Press the bottom portions of the side clasps with your thumb and index fingers and pull the adapter away from the phone.
- Last, move the accessory connector cover back to the accessory connector and press it so it is securely in place.

Accessories

AC Travel Charger and International Plug Kit

The AC Travel Charger and International Plug Kit provides rapid charge for optimal performance. The AC Travel Charger plugs directly into the power connector on the right side of your adapter.

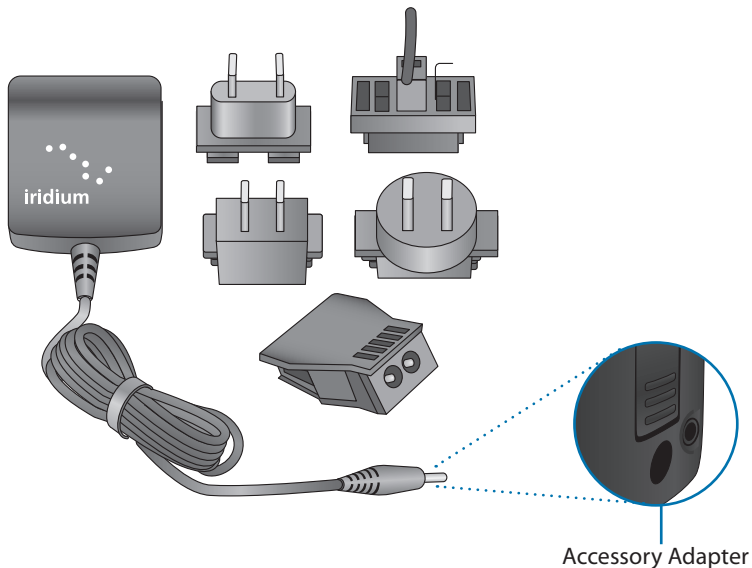

- Can be used to power the phone when the battery is depleted.

- The battery must be installed when using the charger to power the phone.
- Includes five international plug adapters for use in many countries around the world.
- Allows you to use the Iridium Extreme™ while recharging the battery. The battery should not be allowed to discharge fully.

Headset

The convenient headset provides both an earphone and microphone in one small piece for simple hands-free and private telephone conversations. The headset plugs directly into the jack on the right side of your phone.

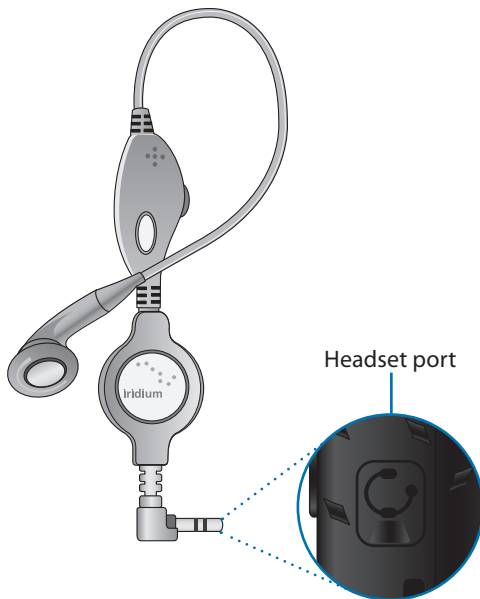

Auto Accessory Charger

The Auto Accessory Charger provides a rapid charge for your phone from DC charging sources such as cars, boats, or solar charging panels. The Auto Accessory Charger plugs directly into the power connector on the right side of your adapter.

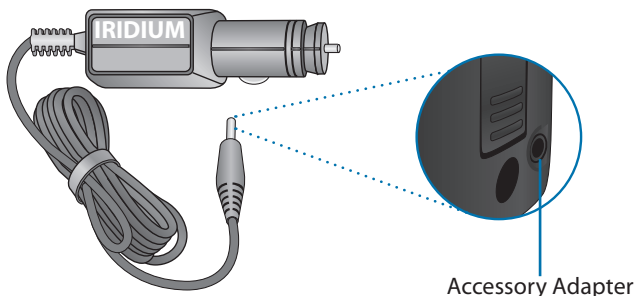

External Antenna

The External Antenna is designed to allow you to use your phone while inside an enclosed area in close proximity to an open view of the sky. The External Antenna screws on to the TNC connector on your Accessory Adapter. To install, hold the Accessory Adapter's TNC connector in place while attaching the External Antenna and take care not to twist the wires. Then attach the Accessory Adapter with connected External Antenna to your phone and place the External Antenna in an area with a view of the open sky for use.



Leather Case

The leather case is designed to hold your phone, help protect it from scratches, and allow you to attach it to other items with the built-in clip. To attach the leather case to your phone, ensure the bottom of the case is open and insert the phone through the bottom and push it towards the top. The leather case is designed to be used either with our without the accessory adapters so an extended leather flap and Velcro is provided for this purpose.

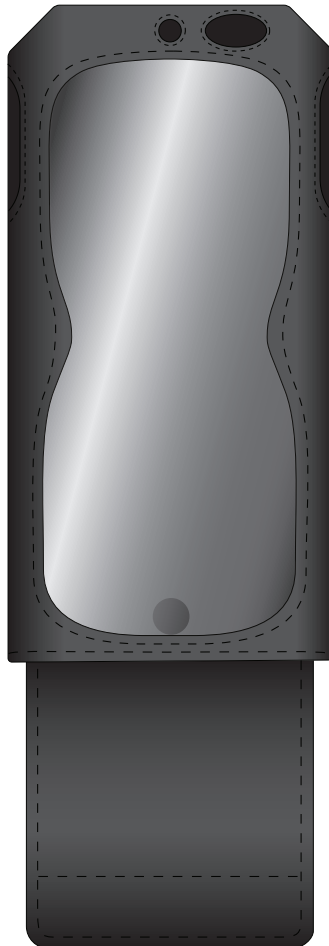

USB Data Cable

The USB data cable allows you to connect your Iridium Extreme™ phone to a laptop in order to provide a data connection for email or web access. Software and installation instructions are provided on your included CD-ROM or can be obtained from your service provider. The USB Data Cable plugs directly into the mini-USB connector on the left side of your Accessory Adapter. Make sure your Accessory Adapter is connected to your phone, the USB cable is attached to your laptop, and software is installed for use. Airtime charges apply for data service usage.



Indicators



Status Indicator LED

The status indicator at the top of the phone has the following meanings:

LED is ...	Indicates
Alternating red and green	Call in progress; ringing, dialing or in call.
Flashing green	Network is available and SIM status okay. Phone is idle.
Flashing red	No connection to network or valid SIM card is required.

SOS Indicator LED

The status indicator at the top of the phone has the following meanings:

SOS LED is ...	Indicates
Flashing red	Obtaining location
Flashing orange	Sending location
Flashing yellow	Location sent
Flashing green	Location sent and will wait for five (5) minutes to obtain and send new location.

Display Status Indicators and Icons

The following icons appear in your display to provide you with information about the phone's activity.

Main Screen Components

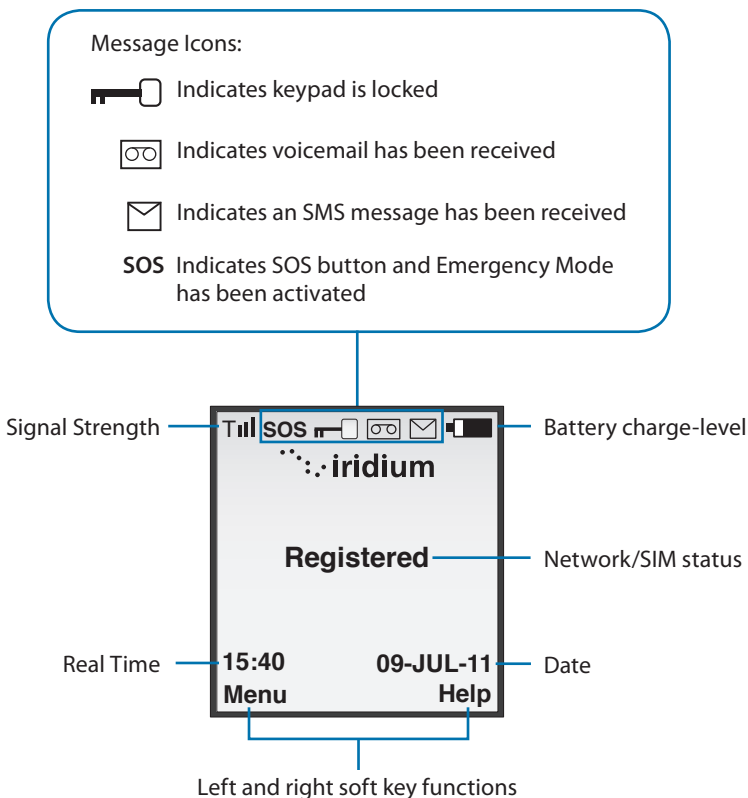

Menu Components

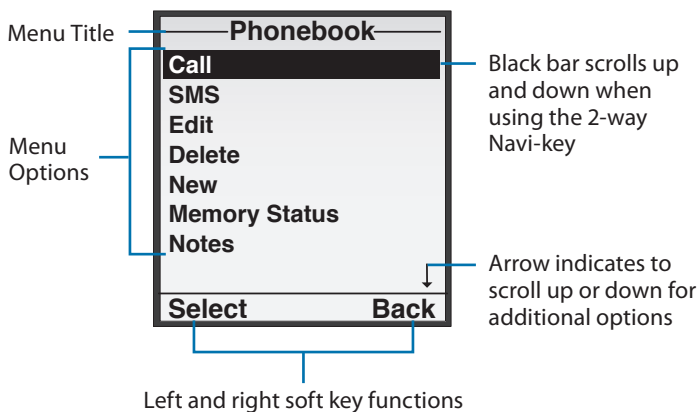

4: Getting Started

Using the SIM Card

You will receive a Subscriber Identity Module (SIM) card from your service provider that is required for use with your phone. The SIM card is a smart card that contains your service details and memory for storing phone book entries and messages.

Your phone has limited functionality without the SIM card, so you want to install the card before using your phone.

SIM Card Care

You may want to keep your card with you when you are not using your phone. This helps keep your personal information secure and gives you access to your service even if your phone is not available.

Important: Do not bend or scratch your SIM card, and avoid exposing your card to static electricity, water or dirt.

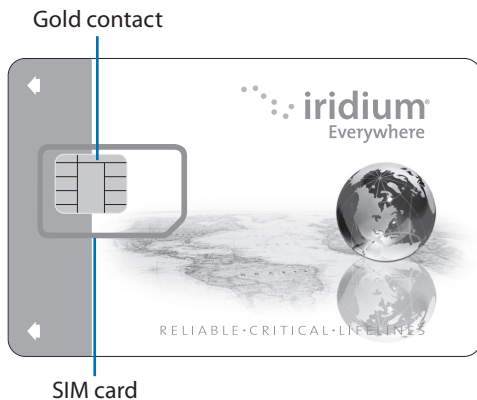

Insert the SIM Card



1. Remove the SIM card from the larger card.
2. Remove the battery as shown on page 27.
3. Slide the SIM card into the SIM card slot. Follow the card orientation shown on the decal. Be sure the gold contact is facing down.
4. Slide the retaining clip down until you hear a 'click' to secure the SIM card.



- SIM Decal
- SIM Door
- SIM Card

Remove the SIM Card

First unlock the retaining clip, then swing out the retaining clip and slide the SIM card out of the slot.

Battery Pack Information

All batteries may cause serious injury or property damage, particularly if handled improperly or used after damage.

Warning!

Improper treatment or use of batteries may present a danger of fire, explosion, leakage, or other hazard.



Make sure to follow all of the following safety guidelines:

- Do not disassemble, crush, puncture, shred or otherwise attempt to change the form of the battery.

- Do not let the phone or battery come in contact with water. Water can lead to corrosion of the phone's circuits.



- Do not allow the battery to touch metal objects. Contact with metal objects can cause the battery to heat and possibly explode.



- Do not place your battery near a heat source. Excessive heat can damage the phone or battery by causing it to swell, leak or malfunction. Do not dry a wet or damp battery with an appliance or heat source, such as a hair dryer or microwave oven. Do not leave your phone in an automobile or other vehicle with high temperatures.

- Do not drop the battery or the phone because the impact can damage them.

- Do not dispose of batteries in a fire, because they may explode.



- Contact your service provider or Iridium if your phone or battery has been damaged from dropping or high temperatures.



WARNING!



Use of non-Iridium batteries or chargers may present a risk of fire, explosion, leakage or other hazard.



Important

Use only Iridium original products for safety and quality assurance. Iridium's warranty does not cover damage caused by use of non-Iridium batteries.

Battery Charging

Batteries may be charged and discharged many times, but eventually they wear out.

Important: Follow these guidelines when charging your battery:

- Keep your battery near room temperature. Never expose batteries to temperatures below 0°C (32°F) or above 45°C (113°F) when charging.
- New batteries are not fully charged and may take more time to charge.

Battery Disposal

Proper battery disposal is not only important for safety but also benefits the environment. Consumers should recycle used batteries and telephones in accordance with applicable national, state or local laws and regulations.



Under EU requirements, all electrical and electronic products must be taken to separate collection at the end of their working life and must not be disposed of as unsorted municipal waste.

Do not dispose of your battery in a fire.



Remove and Install the Battery Pack

The back panel of the phone is the battery pack. You need to remove the battery pack to insert the SIM card or replace the battery.

To Remove the Battery Pack



To Install the Battery Pack



1. Before installing battery pack, ensure D-ring is raised and in vertical position (as pictured)
2. Hold the D-ring in the vertical position and place bottom of battery in first, aligning the battery pack pegs to ensure that the battery is fully seated at the bottom
3. Push the top portion of the battery in ensuring that the D-ring pin is aligned properly when pressed into the phone
4. Once the battery is fully inserted, rotate the D-ring clockwise 90 degrees and put the D-ring into the stowed position

Charging the Battery

Use the AC travel charger or auto accessory adapter to charge the Iridium Extreme™.

Important: The battery should only be charged in environments between 0°C (32°F) to 45°C (113°F).

Charge the Battery Pack

1. Connect the travel charger or auto accessory charger to the accessory adapter and ensuring that the accessory adapter is attached to your phone.



Power connector on adapter

2. Plug the AC travel charger or auto accessory adapter into the appropriate power source. The phone beeps.
3. The battery symbol on the LCD display flashes.

Note: Calls can still be made or received while the battery is charging; however the battery charges faster if the phone is turned off. When the Iridium Extreme™ is not in use the battery takes approximately 4 hours to fully charge.

You must wait a minimum of 5 seconds before powering on the Iridium Extreme™ after you have disconnected from the charger.

Checking Battery Charge Level

Low Battery Warning

Your phone has two ways to indicate that the battery is low and only a few minutes of talk time remains:

1. The battery charge indicator appears continuously in the upper right hand corner of the display. When the battery charge is low the icon appears empty, and Low Battery appears on the display.

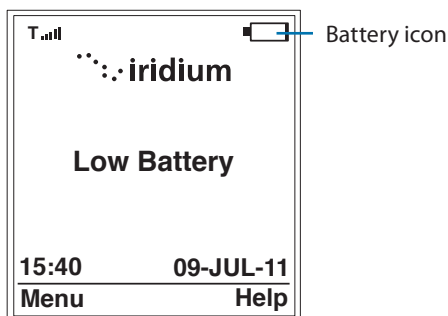

2. A warning tone (two double beeps) sounds.

Note: To help maintain the best battery and phone performance, recharge your battery as soon as possible after you receive the low battery warning.

Start-up Procedure

1. Insert your SIM card if necessary.
2. Turn the phone on by pressing and holding the On/Off button for 5 seconds.

When you turn your phone's power on, the display screen goes through a short animated sequence.

Power on Message

Once your phone is on, one of the following messages may appear.

Message	Directive
Bad Card	See Supplier. Your SIM card has been damaged or incorrectly issued. Contact your service provider for information.

Message	Directive
Check Card	The SIM card is damaged or inserted the wrong way.
Denied	Your phone has seen a network, but has been denied access.
SIM PIN	Enter the four- to eight-digit SIM card PIN code provided by your service provider and press OK to proceed. See "Using the Security Menu" on page 179, for more information about your SIM.
Invalid Account	Contact your service provider.
Phone PIN	The phone has been locked. To unlock the phone, you must enter the correct Phone PIN number.
PIN Blocked	When the PIN number has been entered incorrectly three times in a row, the phone automatically blocks the PIN. To unblock the pin, enter the PUK1 code for the phone by entering **05* from the main screen.
PIN 2 Blocked	When the PIN2 number has been entered incorrectly three times in a row, the phone automatically blocks the PIN. To unblock the PIN2 enter the PUK2 code for the phone by entering **052* from the main screen.
Registered	Your phone is now registered with the network.
Searching for network...	The phone is attempting to establish communications with the satellite network. This message appears while your phone searches for a network connection.
CAUTION! Emergency call recipient has not been configured. Refer to user guide and edit.	Emergency Actions is set to Message and Call or Call Only and a Call Recipient has not been configured. See Chapter 14: GPS and Location Based Services for information on configuring the Emergency Call Recipient. Press Edit to configure the Emergency Call Recipient or Cancel to proceed to the main window.

Message	Directive
CAUTION! Emergency SMS recipient has not been configured. Refer to user guide and edit.	Emergency Actions is set to Message and Call or Message Only and SMS contact has not been configured. See Chapter 14: GPS and Location Based Services for information on configuring the Message recipient. Press Edit to configure the Message Recipient or Cancel to proceed to the main window.

Phone Operation

Normal Operation

Hold the phone as you would any other telephone. Fully extend the antenna then rotate the antenna to either the left or right detent. The antenna should be vertical to the ground and have a clear unobstructed view of the sky.

Tips on Efficient Operation

For your phone to operate most efficiently:

1. Keep your phone battery charged to ensure that the phone is ready for use when needed.
2. Fully extend your antenna and rotate top portion of antenna as needed to ensure antenna is pointed directly up while in use.
3. Make sure the antenna has a clear unobstructed view of the sky.
4. Do not touch the antenna unnecessarily when the phone is in use.
5. Contact with the antenna affects call quality and may cause the phone to operate at a higher power level than otherwise needed.
6. Do not wear the phone on your body while making calls with the headset accessory. Wearing the phone on the body can interfere with proper phone operation, since the antenna requires a clear unobstructed view of the sky to access the Iridium® satellite network.
7. Once you complete your call and are finished with the phone, return the antenna to the center upright position and gently retract the antenna before carrying or storing the phone between uses.
8. For backup, keep a written record of all important information stored on your phone.

Placing a Call

Before you place a call:

1. The phone must be powered on.
2. SIM card inserted.
3. Phone is unlocked.
4. Have a clear direct view of the sky to be in contact with the network.
5. Antenna should be extended and pointed up towards the sky.

Dial the Number

As you enter a phone number, the digits are displayed on a single line that scrolls across the display.

1. Enter the number using the key pad. As you begin entering digits, you see **Options** displayed above the left soft key and **Clear** displayed above the right soft key.

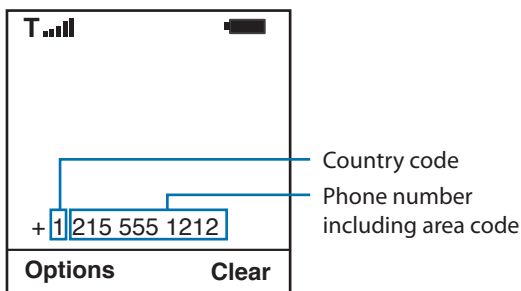

The phone number must be entered in international format: + or 00 [country code][phone number]. Your Iridium Extreme™ will automatically enter a + for the international access code so the only numbers that are required to add are the country code and phone number.

Note: All Iridium subscriber numbers begin with county code of **8816** unless an alternative access number has been issued by your service provider.

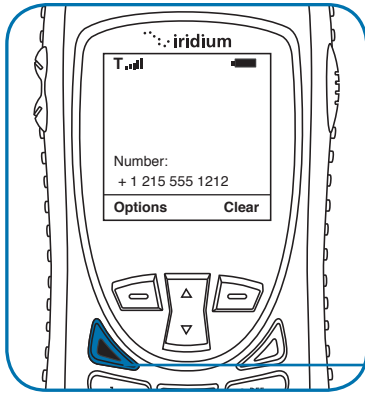

2. Press the **green** key.

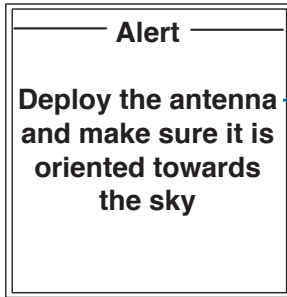

Note: You receive this message when the antenna is not fully extended from the Iridium Extreme™.

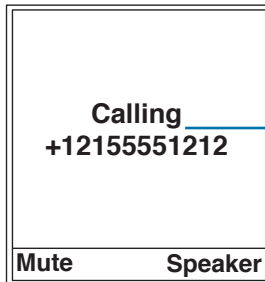

3. Calling followed by the number you dialed appears in the display.

If the call does not connect, one of the following messages appears.

Message	Directive
Busy Try Later Or Please Try Later	The phone is unable to access the network. Try again in a few minutes
Could not place call. No connection to the network	The phone is unable to access the network.
Restricted Area	The phone is unable to access the network. Move to an area where calls are allowed.

Note: If you have disabled the timer, **Connected** display.

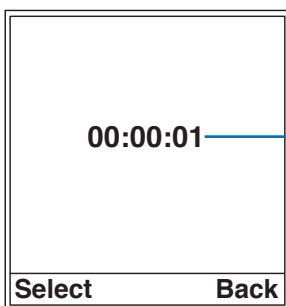

4. A timer keeps track of the duration of each call.

End a Call

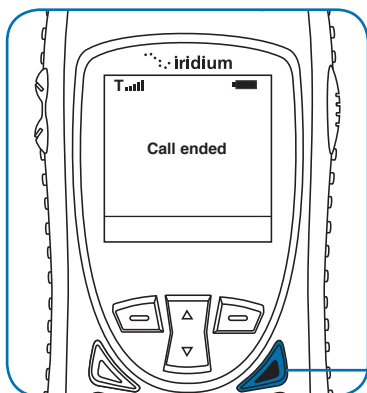

Press the **red** key.

Re-dial Last Number Called

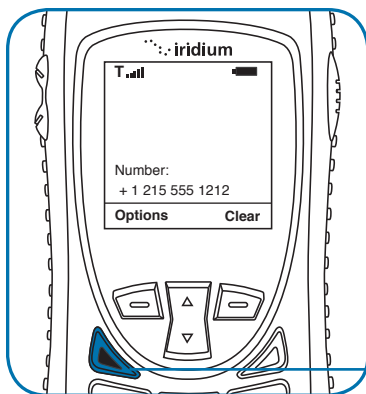

Press the **green** key twice.

Receiving a Call

Before you receive a call:

1. The phone must be powered on.
2. A valid SIM card must be inserted.
3. Phone is unlocked.
4. The phone must be connected with the network.

There are two scenarios for receiving calls depending on the antenna position:

1. Antenna extended
2. Antenna stowed; that is, in the down position.

Receiving a call with the Antenna Extended

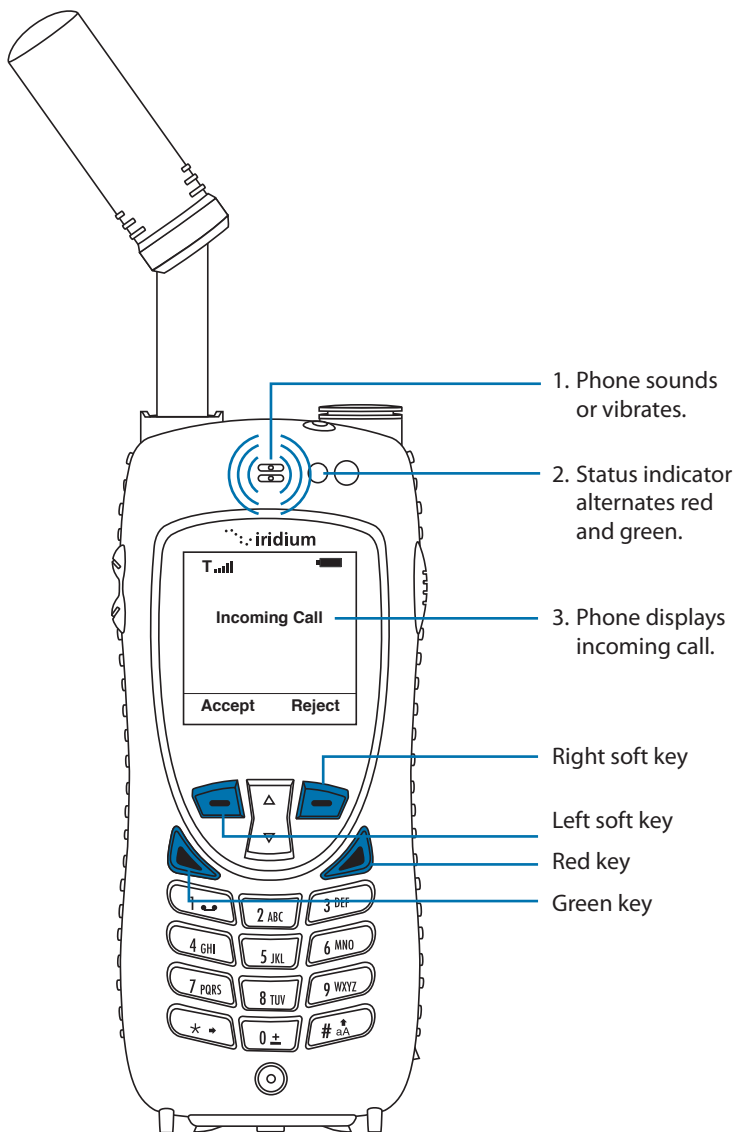

Answering the call with the Antenna Extended

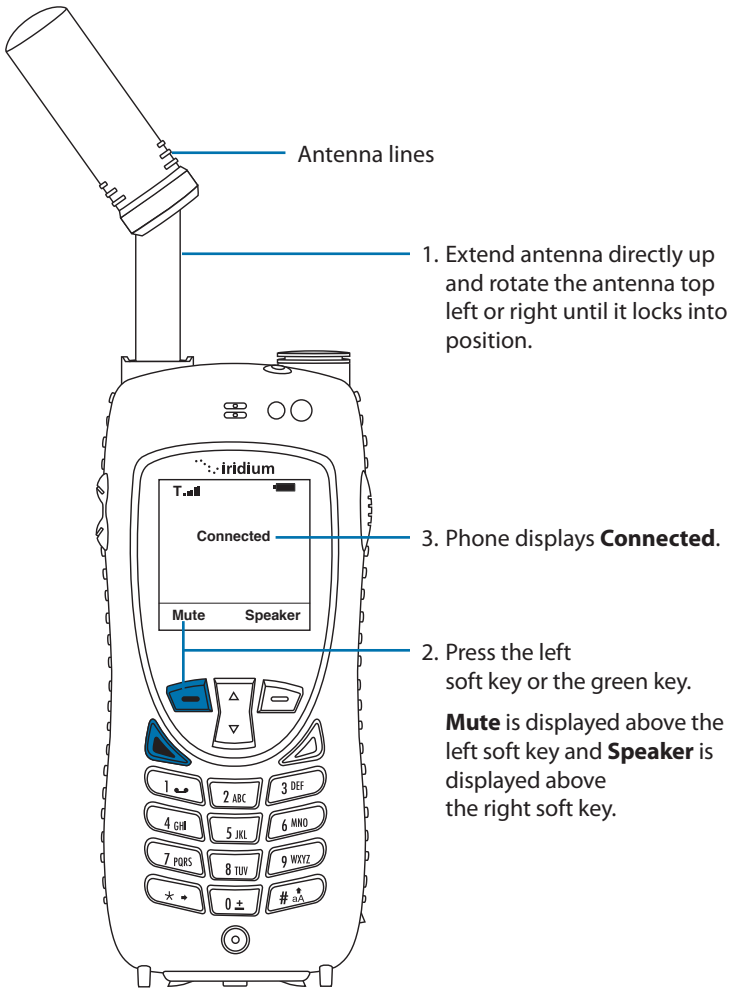

If the call does not connect properly, the following message appears:

Message	Directive
Call Failed	The antenna is not properly positioned or the network signal is not strong enough.

Receiving a Call with the Antenna Stowed

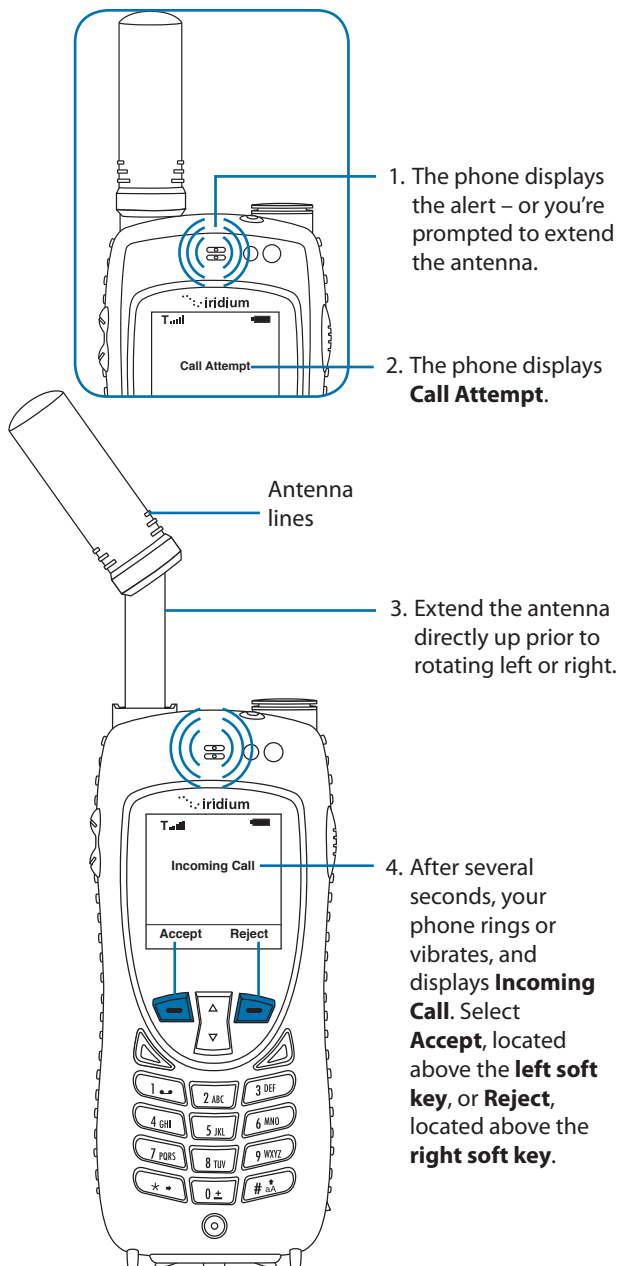

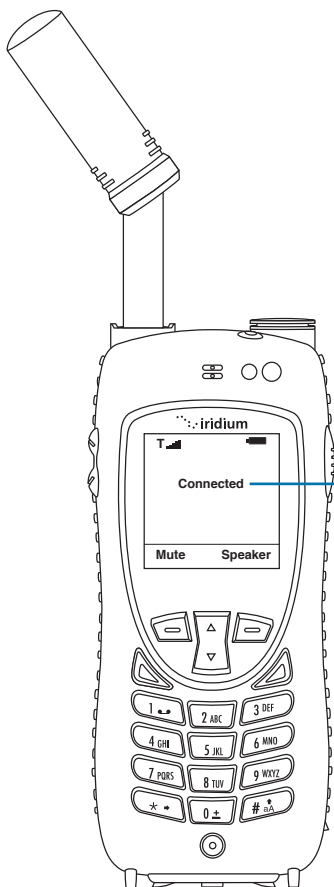

5. The phone displays **Connected**.

If the call does not connect properly, the following message appears:

Message	Directive
Call Failed	The antenna is not properly positioned or the network signal is not strong enough.

Muting a Call

For privacy during a call, use the mute feature. You hear the party on the other end, but they do not hear you.

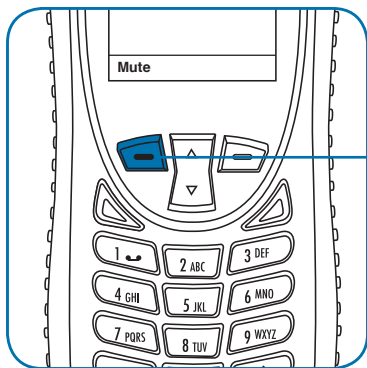

To mute the call:
Press the **left soft key**.

To un-mute the call:
Press the **left soft key** again.

Speaker Phone

To allow the call to be shared with other people within close proximity to your phone, use the speaker phone feature. In this mode the speaker in the rear of the phone is used instead of the normal earpiece/receiver.

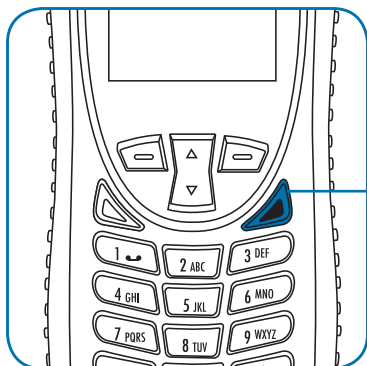

To use speaker phone: Press the **right soft key**.

To switch back to the earpiece: Press the **right soft key** again.

Speaker Volume

The speaker volume can be adjusted either while on a call or with the Volume and Tones menu located under the Setup menu.

1. Increase the speaker volume by pressing the **upper volume control**

key, during a call. Once you are satisfied with the volume press **OK**. If you would like to cancel the change to the volume press **Back**.

2. Decrease the speaker volume by pressing the **lower volume control** key, during a call.

As you press the keys, you hear the new volume level. The bar graph on the display indicates the volume level; the higher the graph, the louder the volume.

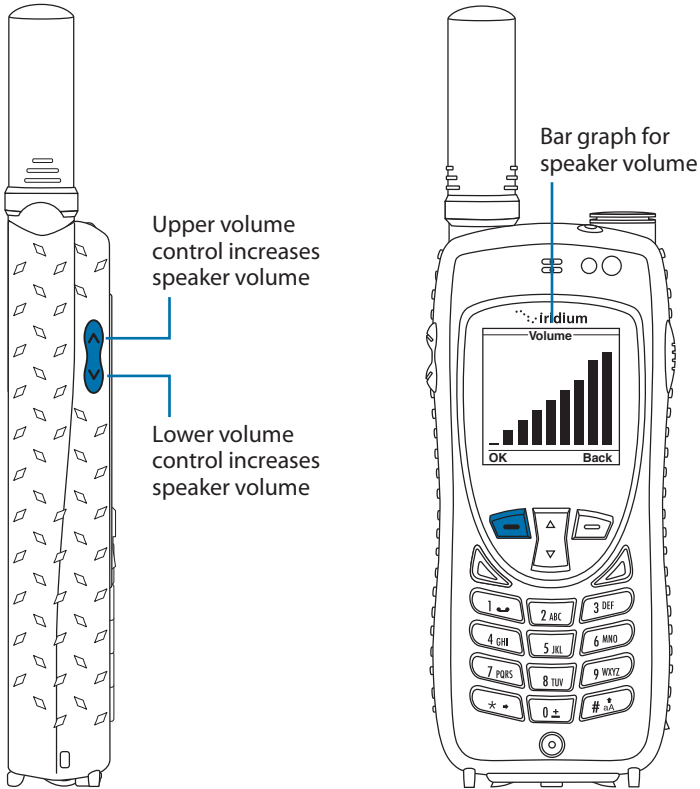

Ringer Volume

The ringer volume may be adjusted with the Volume and Tones menu located under the **Setup** menu.

- Increase the ringer volume by pressing the **upper volume control** key.
- Decrease the ringer volume by pressing the **lower volume control** key.

- As you press the keys, you hear the new volume level. The bar graph on the display indicates the volume level; the higher the graph, the louder the volume.

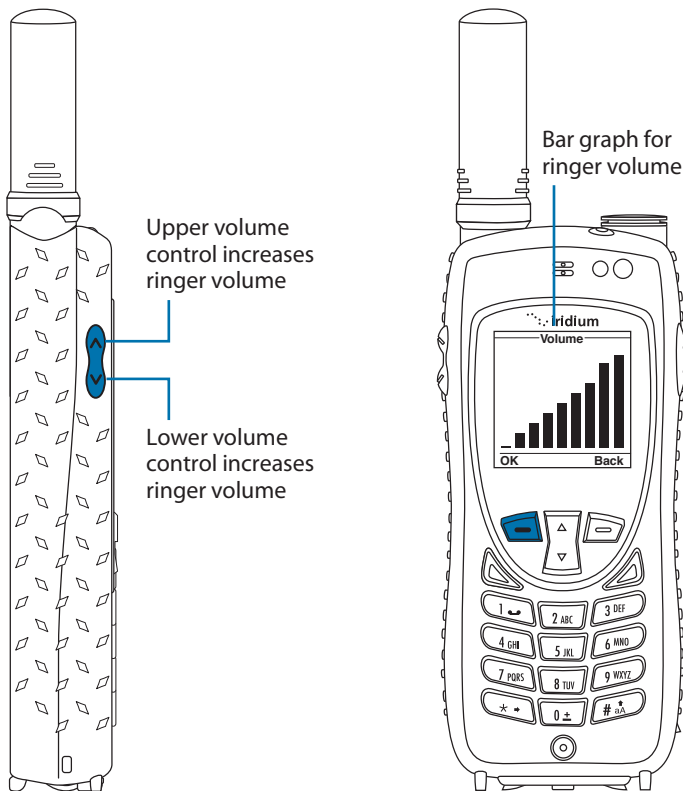

Unanswered Calls

If you are away from your phone or choose not to answer a call the screen displays the number of missed calls.

Messages from Missed Calls

If you are not able to answer your phone, or are not connected to the network, callers can leave you a voice message which can be accessed from the voicemail system. When connected to the network, a message icon appears on your screen indicating a new voicemail message.

For more information on retrieving messages, see "Using the Voicemail Menu" on page 113.

Locking and Unlocking the Keypad

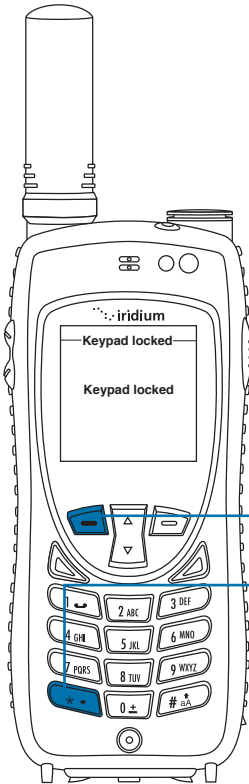

To prevent accidental phone usage you can **lock the keypad** by:

1. Press the **left soft key**, labeled **Menu**.
2. Press the *** key** to lock the keypad. A message will flash indicating the keypad is locked.

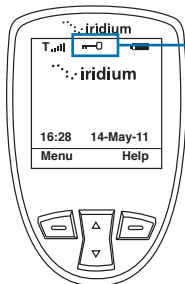

3. The **Main Screen** will now have a lock symbol.

Note: All keys with the exception of the power key are locked. You can still answer an incoming call by pressing the green key or the left soft key when the keypad is locked.

Unlocking the Keypad

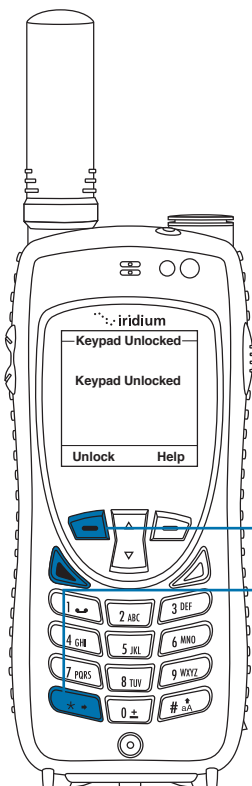

1. Press the **left soft key** labeled **Unlock**.
2. Press the *** key**. A message flashes indicating the keypad is unlocked, and the lock symbol no longer appears on the main screen.

5: Using Menus and Keys

Many of the phone's features are organized into lists of options called menus. Use the phone keys to navigate these menus.

Using the Keys

The Soft Keys

When you press the soft keys the function appears above the key on the display screen. The function varies depending on the menu.

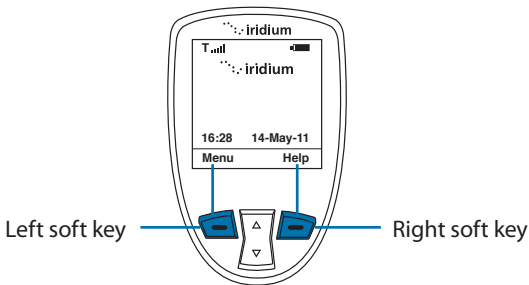

The 2-way Navi-key

Press the 2-way Navi-key up to step through the options on a menu screen.

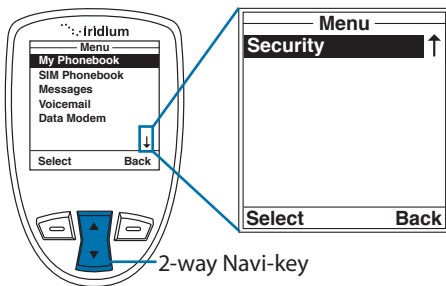

Important: When an arrow appears on the bottom of any menu screen it indicates more options to follow. To see all options, you must continue to press the 2-way Navi-key.

The Keypad

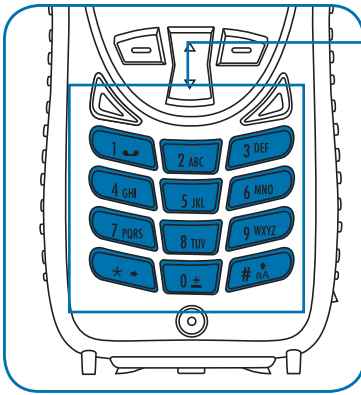

The numbered and alphabetized keys make up the Keypad. Use the keys to enter text, numbers and punctuation marks into various fields in display screens. See entering characters on page 56 for more information.

Using the Menus

To Access the Main Menu

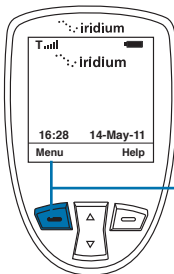

Starting from the **Main Screen**:

Press the **Left soft key**, labeled **Menu**.

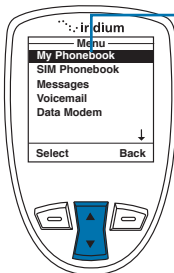

The **Main Menu** appears. The Main Menu consists of:

- My Phonebook
- SIM Phonebook
- Messages
- Voicemail
- Data Modem
- Call History
- Setup
- Security

Note: You cannot access the Menus during a call.

To Access Main Menu Options

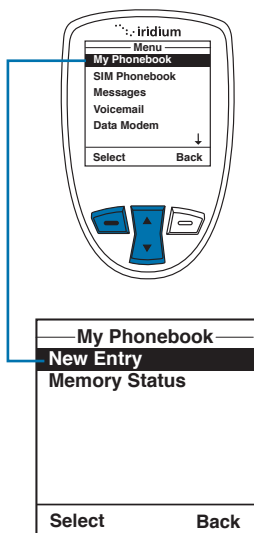

Starting from the Main Menu, use the **2-way Navi-key** to scroll to the desired menu option until it is highlighted.

Press the **left soft key**, labeled **Select**. The option you selected appears. Continue this procedure for each sub-menu.

To Return to a Menu

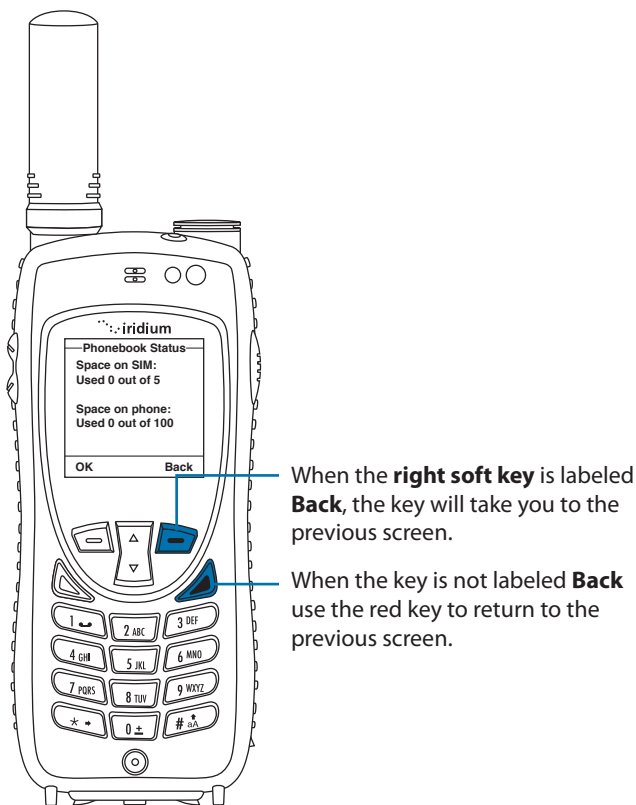

Note: In all other instances the red key will return you to the Main Screen.

Entering Characters

Many of the menu screens have fields where you need to enter information such as names and addresses. To enter this information you need to use the keys on the keypad. Entry of text with the keys on the keypad is discussed in detail in “Traditional Text Entry” on page 59 and “Predictive Text Entry” on page 65.

When creating phonebook entries and/or composing text messages; you can use both the side volume keys and the navigation key to help navigate between characters or lines of text without deleting.

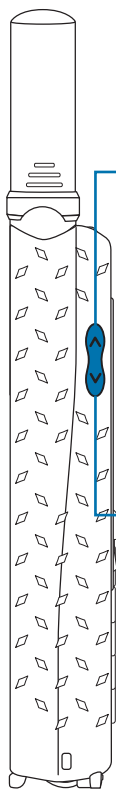

The **up volume key** takes you backwards through text when you are editing a phone book entry. If you are editing a message, it moves you up a line of text. Choosing **Up** on the **2-way Navi-key** moves backwards through message text.

The **down volume key** takes you forward through text when you are editing a phone book entry. If you are editing a message, it moves you down a line of text. Choosing **Down** on the **2-way Navi-key** moves forward through message text.

6: Traditional Text Entry

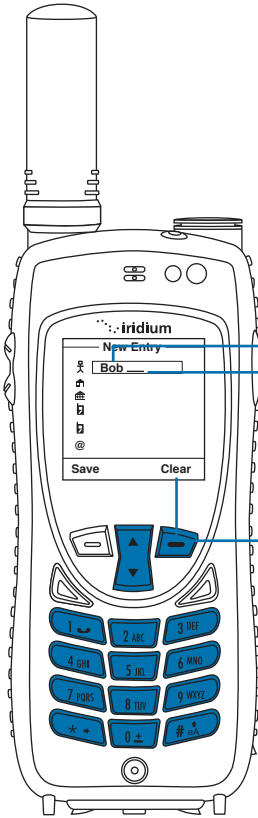

To enter characters via traditional method:

1. Enter a character by pressing the appropriate keys on the keypad. See keypad guide below.
2. The cursor moves to the next character position.
3. To delete a character press the **Right Soft Key**, labeled **Clear**.
4. Repeat steps 1 and 2 as many times as necessary.

Entering Characters

Many of the menu screens have fields where you need to enter information such as names and addresses. To enter this information you need to use the keys on the keypad. Each key represents a set of letters.

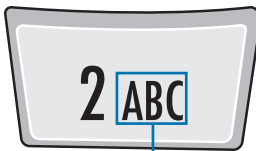

For Example: Use the number 2 key for letters A, B, and C.

- Press 1 time for A
- Press 2 times for B
- Press 3 times for C

Note: Press the **# key** to toggle between caps, lowercase, first letter capitalization, and digits. The mode currently selected is displayed in the top left corner of the screen; the modes are indicated as **ABC**, **abc**, **Abc**, **123**.

Keypad Guide

Key	Available Characters
1	. (period) /1
2	A/B/C/2
3	D/E/F/3
4	G/H/I/4
5	J/K/L/5
6	M/N/O/6
7	P/Q/R/S/7
8	T/U/V/8
9	W/X/Y/Z/9
0	_ (space)
*	next character
#	shift up
Right Soft Key	backspace / exit

Entering Punctuation

Pressing * (**star**) key takes you to a symbols menu with a list of the most commonly used punctuation marks and symbols.

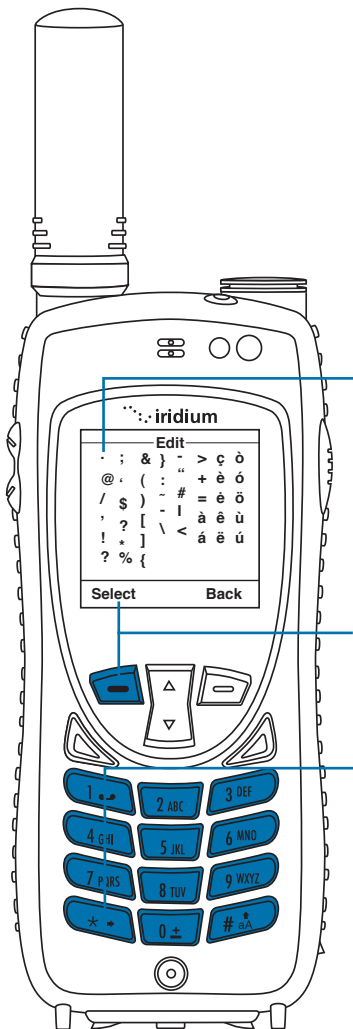

Using the **2-way Navi key**, cycle through the screen until you reach the desired symbol.

Press the **Left Soft Key** labeled **Select**.

Press the **Star** key to open the symbols menu.

Entering Numbers and Symbols into Text

There may be times when you need to add numbers into a message that you are writing. For example, to send someone a phone number as part of a text message.

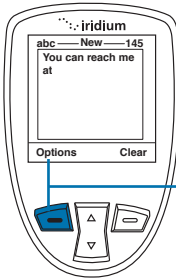

Starting from a text entry field:

1. Press the **left soft key** labeled **Options**.

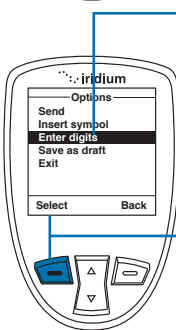

2. The **Options** screen appears. Using the **2-way Navi-key** scroll until **Enter digits** is highlighted.

3. Press the **left soft key** labeled **Select**.

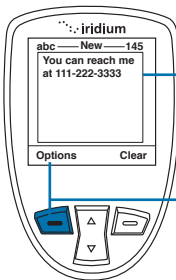

4. The original text now appears, but you are in the number entry mode.

5. Press the **left soft key** labeled **Options**.

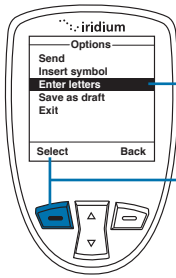

6. The **Options** screen appears. Using the **2-way Navi-key** scroll until **Enter letters** is highlighted.
7. Press the **left soft key** labeled **Options**.

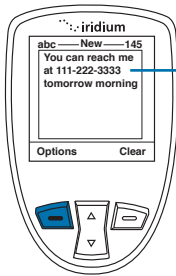

8. The original text screen now appears and you can continue to enter text in the letter entry mode.

Note: Use this same procedure for entering symbols into text by choosing **Insert** symbol in the **Options** menu. You can also press the *** key** as a shortcut for accessing the symbol menu (see “Entering Punctuation” on page 62).

7: Predictive Text Entry

Predictive text is implemented on the Iridium Extreme™ and affects the following areas:

- Creating an SMS/Email
- Adding Notes to an existing Phonebook entry
- Entering the Name field for a Phonebook entry (LetterWise only)

Predictive text is not set on a new phone by default, it must be enabled. To do so, start at the main screen and:

1. Press the Menu softkey
2. Select "Setup" (6 clicks down)
3. In the Setup menu, select "Language" (4 clicks down)
4. In the Language menu, select "Text entry"

In the Text entry menu, Multi-tap is the default selection. Multi-tap has no language sensitivity, other than the fact that it provides standard Western characters. To choose predictive text, select one of:

- English
- Français
- Español

Once you have made this change, all SMS entry and entry of contacts incorporate Predictive Text capabilities specific to the selected language. Once selected, select the "Back" option twice, then scroll up to "Messages" to use Predictive Text entry for messaging. To change back to "Multi-Tap" in the future, you need to adjust this setting.

Predictive text entry has the following modes:

- WordWise (Ww) which provides word prediction for users who like dictionary-based methods
- LetterWise (Lw) for letter-by-letter prediction for situations where word-based prediction doesn't afford the flexibility that may be required in some situations.

Special character entry has the following modes:

- Punctuation (#?@) for entry of punctuation and special symbols
- Digit (123) for entry of numbers

For all alphabetic languages:

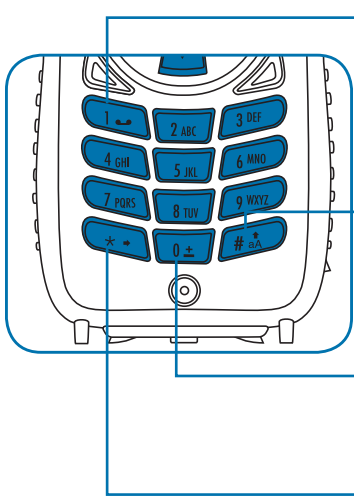

The **1 key** can be used for entering punctuation, however for full and efficient punctuation entry you can switch to **Punctuation mode (123)**.

Pressing the **Pound key (#)** switches between lower and upper case, indicated by the (↑) symbol. This is the **Shift key**.

Pressing the **Zero key (0)** enters a space, indicated by the (↵) symbol. This is the **Space key**.

Pressing the **Asterisk key (*)** enters the next word or letter, indicated by the (→) symbol. This is the **Next key**.

To complete a message, you may need to switch between these four main modes of text entry during message creation:

- WordWise (Ww) - word predictive text entry
- LetterWise (Lw) - letter-by-letter predictive text entry
- Numbers (123) - number entry (non-predictive)
- Punctuation (#?@) - punctuation entry (non-predictive)

The appropriate text entry mode can be selected by pressing the Convenience key on the side of the Iridium Extreme™. The active text entry mode will be displayed on the screen as indicated in the illustrations on the following page.

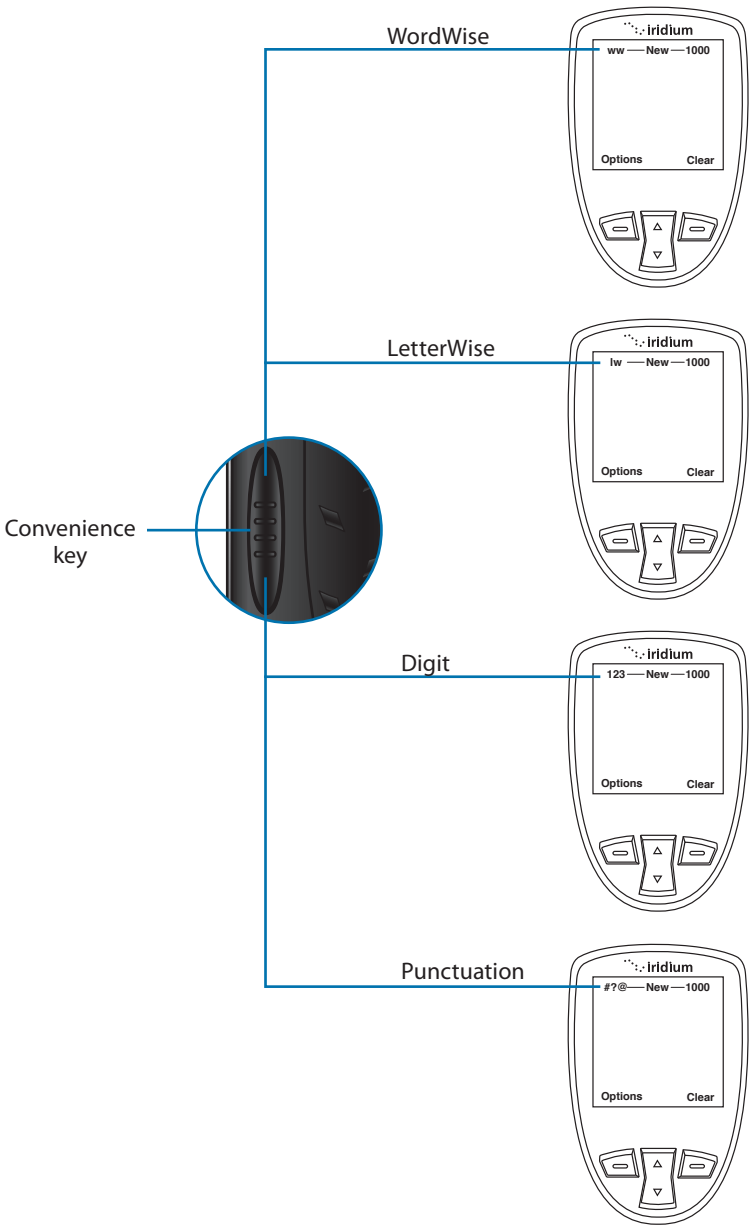

LetterWise Text mode

Press the **Convenience key** until you are in LetterWise (Lw) text mode. Press the key with the desired letter. If it doesn't appear, press the **Next key** (→) until it does. Use the **Right Soft key** (Clear) for backspace and **Space key** (↵) for space. Press the **Shift key** (↑) to switch between lower and upper case.

Note: Apostrophe (') for English entry and hyphen (-) for Russian entry are treated as letters (that is, can be predicted by LetterWise) and are found on **key 5**.

Example: Entering "don't"

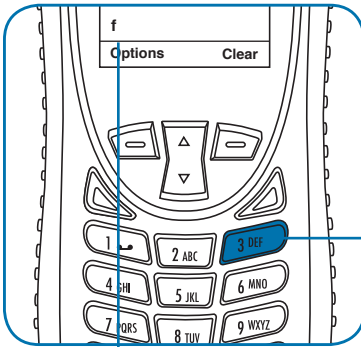

1. Press **key 3**.

Desired letter did not come up.

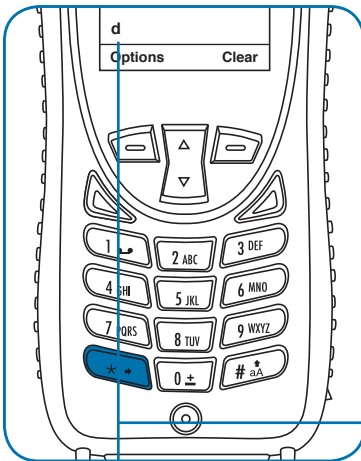

2. Press **Next key** (→) for desired letter. Proceed to next letter of the word.

Desired letter appears.

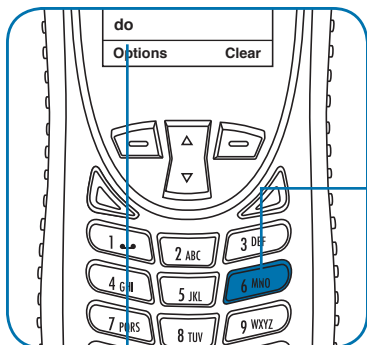

3. Press **key 6**.

Desired letter appears.

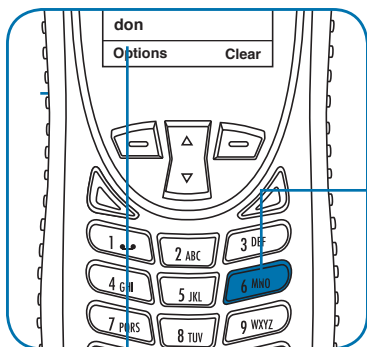

4. Press **key 6** again.

Desired letter appears.

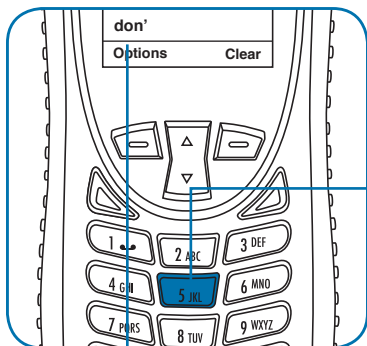

5. Press **key 5** for apostrophe.

Apostrophe is predicted along with letters in English.

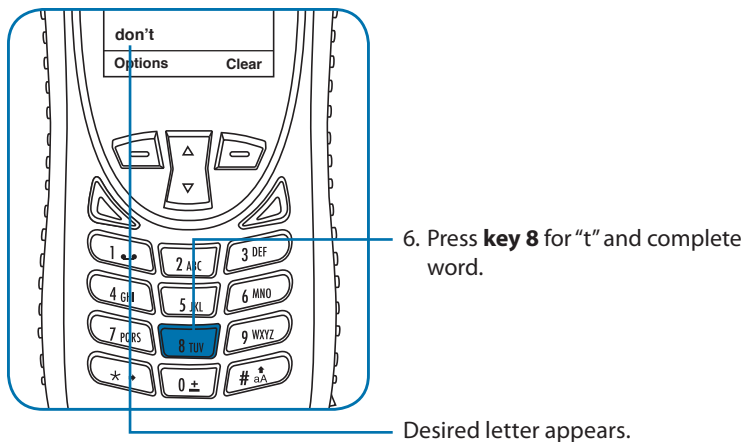

WordWise Text mode

Press the **Convenience key** until the “ww” symbol appears in the top left corner of the screen indicating that you have entered WordWise text entry mode. To enter text in WordWise, press the key containing the first letter you want to type **ONLY ONCE**.

If the correct letter does not appear at first, continue by pressing the key that corresponds to the next letter in your text, and so on.

After pressing the last key in the sequence, the word should appear. However, if the word is underlined (or highlighted), it is possible that an alternate word (which happens to require the same key presses) appeared instead. Just press Next key (→) until the desired word appears.

If the word you are entering is not found in any dictionary you can switch to LetterWise mode by pressing the convenience key and viewing the top left corner of the screen.

During use of WordWise, the 1 key can be used to insert punctuation without changing text entry modes. To insert punctuation, press the **1 key** and then add the appropriate punctuation by using the Next key (→). As an alternative, you may also use the **left option key** either “Insert symbol” or “Enter digits” during WordWise use. This also applies to LetterWise use.

Example: Entering "red"

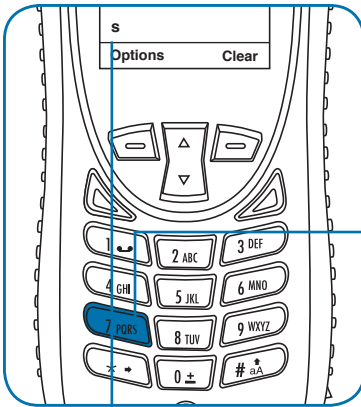

1. Press **key 7**.

Even if the correct letter "r" has not appeared, proceed with the next letter in the word.

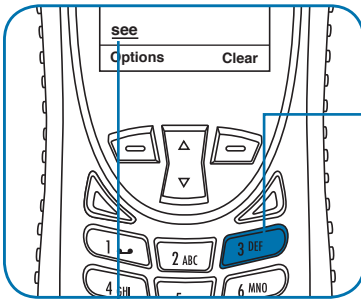

2. Press **key 3** twice for the next two letters "c & d".

The word "see" comes up which is more common than "red". The underline indicates there are other words to choose from.

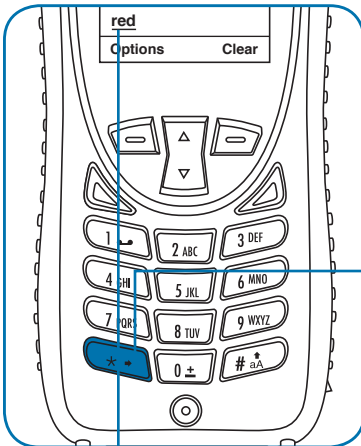

3. Press **Next Key** (→).

The word "red" appears.

Digit mode (123)

There may be times when you need to add numbers into a message that you are composing. Digit mode allows you to use the number keys to enter digits, similar to dialing a phone call. To enter digit mode, press the **Convenience key** until the **123 indicator** appears on the upper left corner of the screen. Enter the numbers required for your message and then use the **Convenience key** to return to the desired text entry mode to complete the rest of the message.

Digit mode may be entered either by pressing the **Convenience key** on the side of the phone, or with the **Options** menu in the **Create Message editor** to "Enter digits". During use of WordWise, the **1 key** can be used to insert punctuation without changing text entry modes.

Punctuation mode (#?@)

Punctuation mode may be entered either by pressing the **Convenience key** on the side of the phone, or with the **Options** menu in the **Create Message editor** to "Insert symbol". During use of WordWise, the **1 key** can be used to insert punctuation without changing text entry modes.

In Punctuation mode, symbols are spread across all keys based on their shape to help you remember which symbol is on each key (see table on following page). For example: ! is on 1 key, ? is on key 2

If there is more than one symbol on a key, press the **Next key** (→) to get the others.

Key	English/French/Russian/Spanish*
0	. , @ °
1	!
2	?
3	% \$ € £
4	_ ~
5	- + = " ^
6	([{ <
7	/ \
8	:: &
9)] } >

* Spanish includes inverted versions of ! and ?.

Once you have selected the appropriate symbol for your message, you may return to your preferred text entry mode by pressing the side convenience key and viewing the top left corner of the screen.

8: Using the Phonebooks

Organizing My Phonebook

Your satellite phone has two primary phonebooks: My Phonebook and SIM Phonebook.

My Phonebook can store up to 100 names and numbers and is completely editable by you. This information is stored directly on your phone. The SIM Phonebook is provided to you by your service provider and/or organization. The entries for the SIM Phonebook are stored directly on the SIM card used with your phone and you cannot create them or edit them from your phone.

	Phone Memory	SIM Card Memory
Personal Numbers	100 entries	155 entries
Fixed Dial Numbers	No entries	40 entries
Phone Number Digits	24	20
Name Characters	24	16

Note: SIM card capacity varies depending upon the card issued by your service provider.

Locating My Phonebook

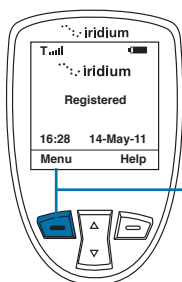

Starting from the Main Screen:

1. Press the **left soft key**, labeled **Menu**.

Note: All instructions for My Phonebook start from the **Main Menu** as shown.

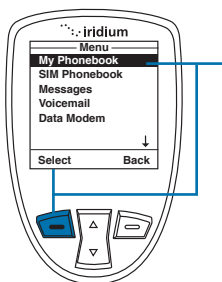

2. The **Main Menu** is now displayed, with **My Phonebook** highlighted press the **left soft key**, labeled **Select** to enter the **Phonebook menu**.

Note: To open the **SIM Phonebook**, use the **2-way Navi-key** to scroll until the **SIM Phonebook** is highlighted.

About the My Phonebook Menu

You can do the following functions using the **Phonebook** menu:

Bob Smith	
Call	
SMS	
Edit	
Delete	
New	
Memory Status	
Notes	
Select	Back

- Call an entry
- Create and send a text message (SMS).
- Edit an entry
- Delete an entry
- Add an entry
- Check the memory status of your Phonebook
- Add notes regarding entries

Add a New Entry to My Phonebook

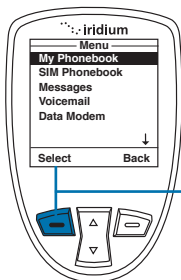

To add information to the Phonebook, use the **New** option. Start at the **Main Menu**, with **My Phonebook** highlighted:

1. Press the **left soft key**, labeled **Select**.

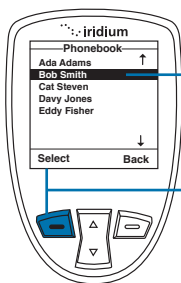

2. The **Phonebook** is displayed.

3. Press the **left soft key**, labeled **Options**.

Note: If there are no entries Empty will be displayed on this screen. If entries are present press the **left soft key** while highlighting any contact.

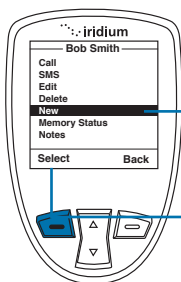

4. Use the **2-way Navi-key** until the **New** option is highlighted.

5. Press the **left soft key**, labeled **Select** to proceed.

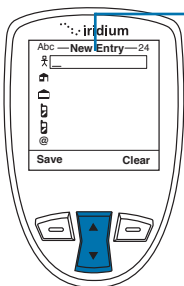

6. The **New Entry** screen is displayed with a list of icons that represent:



Name



Home phone



Work phone



1st cell phone



2nd cell phone



email address

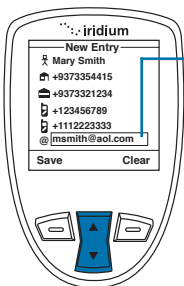

7. Use the **2-way Navi-key** to scroll to each field and the keypad to enter information into the fields.

Note: While entering or editing contact information the side volume keys allow you to move backwards and forwards without deleting.

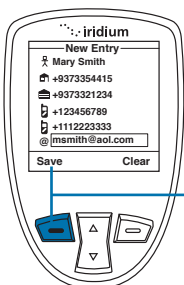

8. Press the **left soft key**, labeled **Save**.

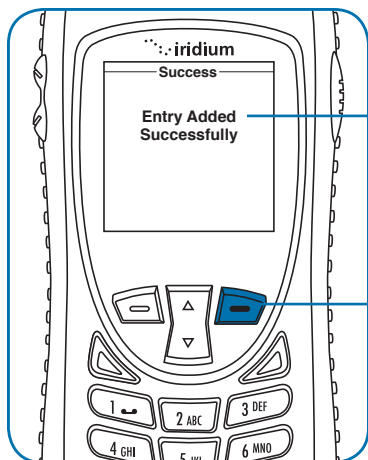

9. A message briefly appears to indicate the contact was entered successfully. The screen reverts to the main **Phonebook** menu.

Press the **red key** to return to the **Main Screen**.

Locating Entries

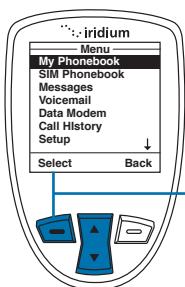

Starting at the Main Menu, using the **2-way Navi-key**, highlight the Phonebook you want to use.

1. Press the **left soft key**, labeled **Select**.

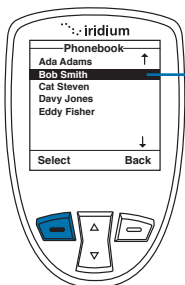

2. The **Phonebook** entries are now displayed in alphabetical order.

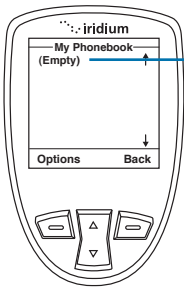

3. If there are no entries **Empty** is displayed. See “Add a New Entry to My Phonebook” on page 77.

Calling an Entry

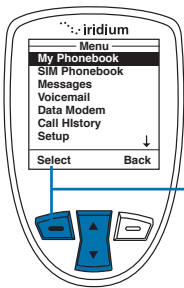

Starting at the Main Menu, using the **2-way Navi-key**, highlight the Phonebook you want to use.

1. Press the **left soft key**, labeled **Select**.

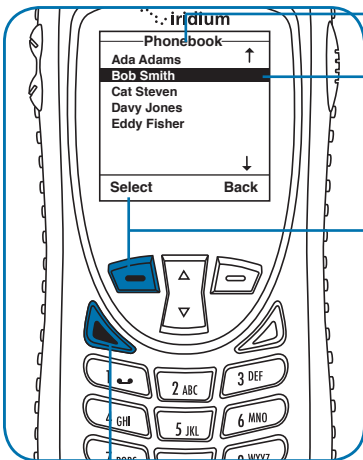

2. The **Phonebook** is displayed.

Use the **2-way Navi-key** to scroll until the desired entry is located.

3. With the entry highlighted, press the **left soft key** labeled **Options**.

Note: You can also press the green key as a short-cut to calling an entry.

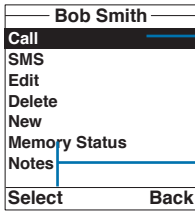

4. The **Phonebook** options are displayed.

5. With the **Call** option highlighted, press the **left soft key** labeled **Select**.

Note: If an entry has more than one number, for example, Home, Work and Mobile, then all numbers are displayed. Using the **2-way Navi-key**, highlight the number to be called and press **Select**.

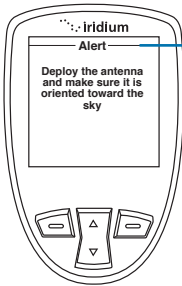

Note: If your antenna is not extended you receive an alert message telling you to extend the antenna.



6. **Calling** followed by the number you dialed is displayed. The call is then connected.

Using the Short Message Service (SMS) Menu

The Short Message Service (SMS) is a text messaging system.

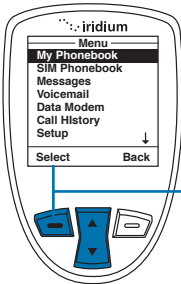

To send a text message Start at the **Main Menu**, using the **2-way Navi-key**, highlight the **Phonebook** you want to use.

1. Press the **left soft key**, labeled **Select**.

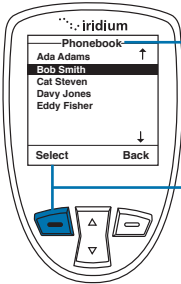

2. The **Phonebook** is displayed. Use the **2-way Navi-key** to scroll until the desired entry is located.

3. Press the **left soft key**, labeled **Options**.

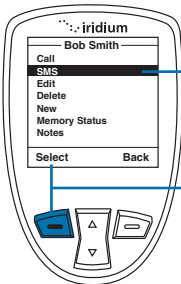

4. Use the **2-way Navi-key** until **SMS** is highlighted.

5. Press the **left soft key**, labeled **Select**.

Note: If an entry has more than one number, for example, Home, Work and Mobile, then all numbers are displayed. Using the **2-way Navi-key**, highlight the number to be called and press **Select**.

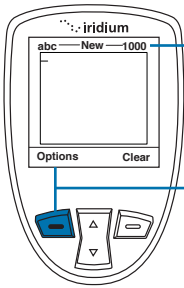

6. The **SMS** Screen now appears. You can enter up to 1,000 characters.

7. Press the **left soft key**, labeled **Options**.

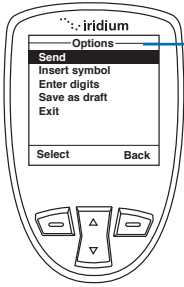

8. The **SMS Options menu** appears. From here you can:

- Send a SMS message
- Insert symbols into your message
- Enter digits
- Save as a draft to send later
- Exit the menu

Sending an SMS Message

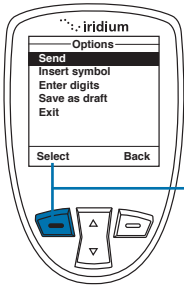

Starting at the **SMS Options Menu**:

1. While **Send** is highlighted press the **left soft key**, labeled **Select**.

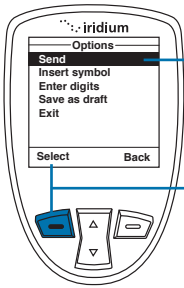

2. A **Send To** screen appears with the entry name and number.

3. Press the **left soft key**, labeled **Send**.

Note: At this time you may elect to send the message to additional recipients by highlighting **New Recipient** and pressing the **right soft key**, labeled **Add**.

Note: At this time you may elect to send the message to additional recipients by highlighting **New Recipient** and pressing the **right soft key**, labeled **Add**.

Adding an SMS Message

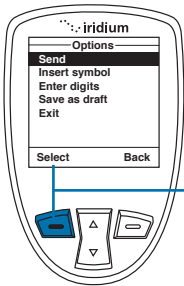

Starting at the **SMS Options** menu:

1. While **Send** is highlighted press the **left soft key**, labeled **Select**.

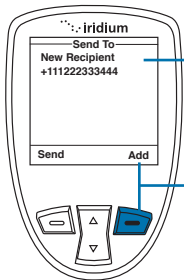

2. A **Send To** screen appears with **New Recipient** and the entry number.

3. Press the **right soft key**, labeled **Add**.

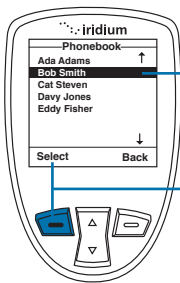

4. A list of contacts now appears. Use the **2-way Navi-key** to scroll to the desired recipient.
5. Press the **left soft key** labeled **Select**, the contact is then added to your recipient list.

Note: Repeat this procedure if you want to send the same message to more than one contact at a time.

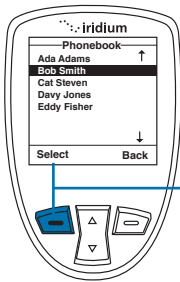

6. Once you are satisfied with the recipient(s) press **left soft key**, labeled **Send**.

Edit an Entry in My Phonebook

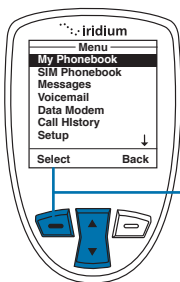

To change information in the Phonebook, use the Edit Option. Starting at the **Main Menu**, with **My Phonebook** highlighted:

1. Press the **left soft key**, labeled **Select**.

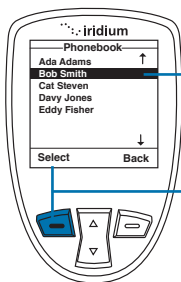

2. The Phonebook is displayed. Use the **2-way Navi-key** to scroll until the desired entry is highlighted.

3. Press the **left soft key**, labeled **Options**.

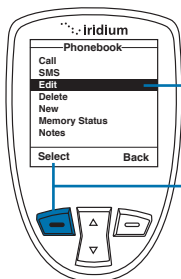

4. Use the **2-way Navi-key** until the **Edit** option is highlighted.

5. Press the **left soft key**, labeled **Select** to proceed.



6. The Edit Screen appears. Edit the entry as needed using the **2-way Navi-key** to scroll to the required field(s). Use the **side volume keys** to navigate backwards (up key) and forwards (down key) without deleting and the **right soft key**, labeled **Clear** to delete characters. Use the keypad to enter new characters.

7. Press the **left soft key**, labeled **Save**.

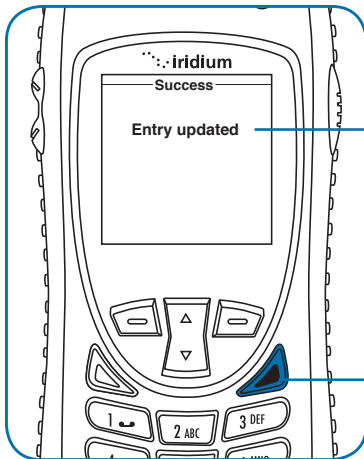

8. A message briefly appears to indicate the entry was updated. The screen then returns to the main Phonebook menu.

9. Press the **red key** to return to the **Main Screen**.

Delete an Entry

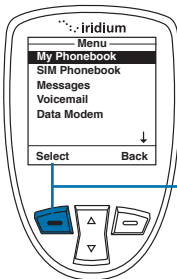

To remove an entry in the Phonebook, use the **Delete** option. Start at the **Main Menu**:

1. Press the **left soft key**, labeled **Select**.

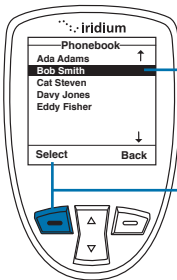

2. The Phonebook is displayed. Use the **2-way Navi-key** to scroll until the desired entry is highlighted.

3. Press the **left soft key**, labeled **Options**.

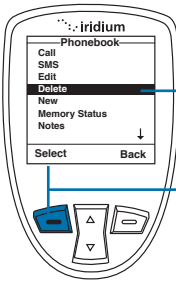

- 4. Use the **2-way Navi-key** until the **Delete** option is highlighted.
- 5. Press the **left soft key**, labeled **Select** to proceed.

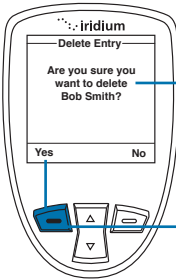

- 6. You receive a message asking if you want to delete the entry. Press the **left soft key**, labeled **Yes**. If you press **No**, the screen reverts to the previous menu.

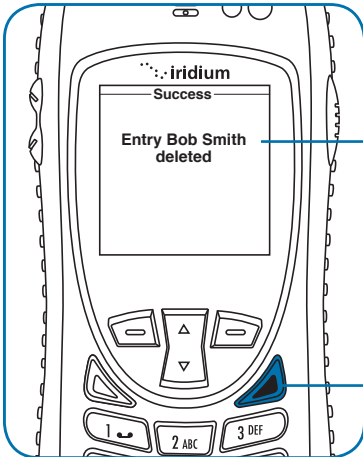

- 7. A message briefly appears to indicate the entry was deleted. The main Phonebook menu then appears.
- 8. Press the **red key** to return to the **Main Screen**.

Viewing Memory Status

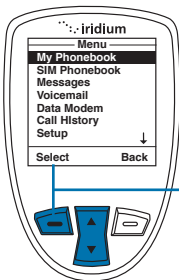

Use this capability to see how many Phonebook memory locations are available in the SIM card memory and phone memory. Start at the **Main Menu**:

1. Press the **left soft key**, labeled **Select**.

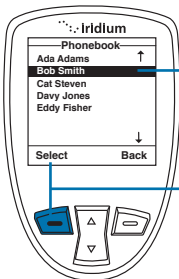

2. The Phonebook is displayed. Use the **2-way Navi-key** to scroll until the desired entry is highlighted.

3. Press the **left soft key**, labeled **Options**.

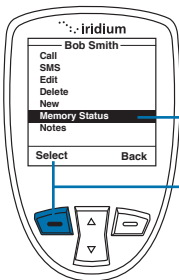

4. Use the **2-way Navi-key** until **Memory Status** is highlighted.

5. Press the **left soft key**, labeled **Select** to proceed.

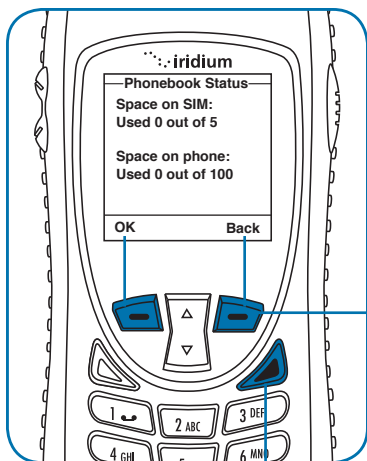

6. The **Phonebook Status** is displayed, showing the space on the SIM and the phone memory.

7. Press the **left soft key**, labeled **OK** or the **right soft key** labeled **Back** to return to the previous screen.

Press the **red key** to return to the **Main Screen**.

Adding Notes to a Phonebook Entry

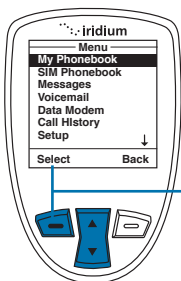

Use this capability to add information regarding an entry.

Start at the **Main Menu**:

1. Press the **left soft key**, labeled **Select**.

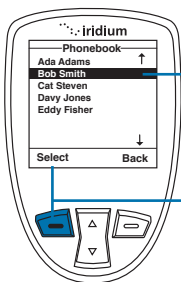

2. The Phonebook is displayed. Use the **2-way Navi-key** to scroll until the desired entry is highlighted.

3. Press the **left soft key**, labeled **Options**.

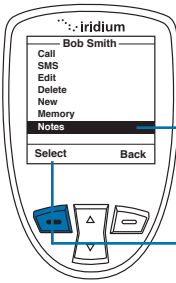

4. Use the **2-way Navi-key** until **Notes** is highlighted.

5. Press the **left soft key**, labeled **Select** to proceed.

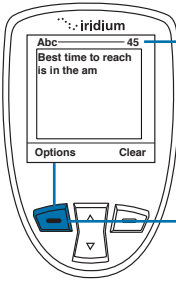

6. A text screen appears. Use the **Keypad** to enter your text.

Note: you can enter up to 64 characters. The character count in the top right corner counts down as you enter text.

7. Press the left soft key, labeled **Options**.

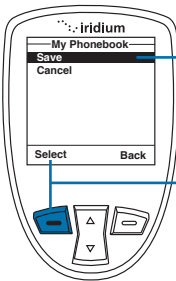

8. A My Phonebook screen appears with **Save** highlighted.

9. Press the **left soft key**, labeled **Options**.

Note: The text you entered is now stored in the Note option for this entry.

Restricted Phonebook

When the Phonebook is restricted, My Phonebook and SIM Phonebook do not appear. The main menu displays Fixed Phonebook only. The Fixed Phonebook cannot be edited.

9: Using the Messages Menu

Locating the Messages Menu

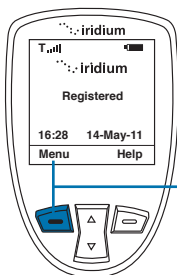

Starting from the Main Screen:

1. Press the **left soft key**, labeled **Menu**.

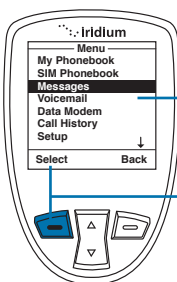

2. The **Main Menu** is displayed. Use the **2-way Navi-key** to scroll until **Messages** is highlighted.
3. Press the **left soft key**, labeled **Select**.

Note: All instructions for the **Messages** menu start from the **Main Menu** as shown.

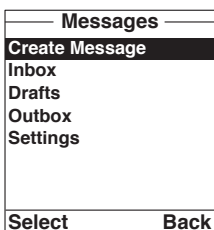

You can perform the following functions using the Messages menu:

- Create messages
- Read, reply, delete, call and forward messages
- Edit stored messages and send
- Enter service center number, set expiry period and enable or disable delivery reports.

Create and Send a new SMS Message to an Email Address not in your Phonebook

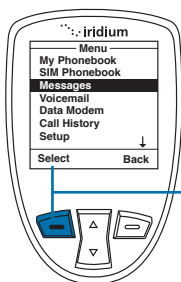

Start at the **Main Menu** with **Messages** highlighted:

1. Press the **left soft key**, labeled **Select**.

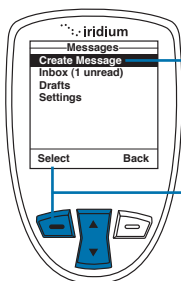

2. The **Create Message** option should be selected. If not then use the **2-way Navi-key** to scroll until it is highlighted.
3. Press the **left soft key**, labeled **Select**.

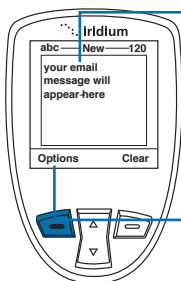

4. Enter your message.

Note: You must begin your text message with the recipients email address, leaving a space between the email address and the beginning of your message.

When your message is complete, press the **left soft key**, labeled **Options**.

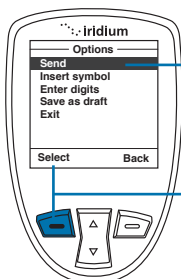

5. The **Send** option should be highlighted. If not then use the **2-way Navi-key** to scroll until it is highlighted.
6. Press the **left soft key**, labeled **Select** to send the message.

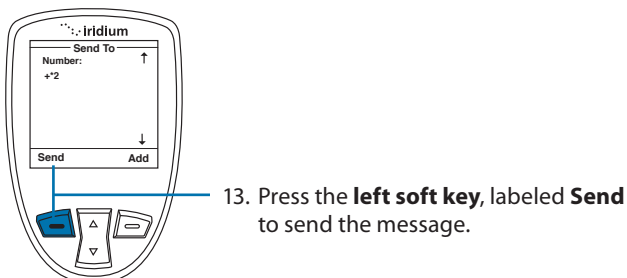
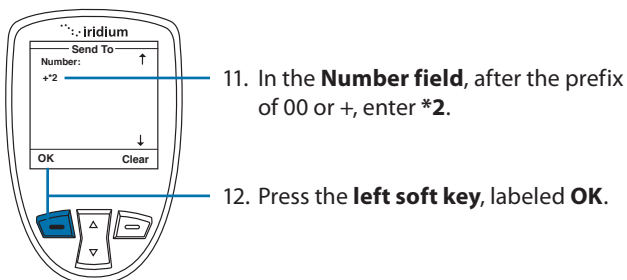
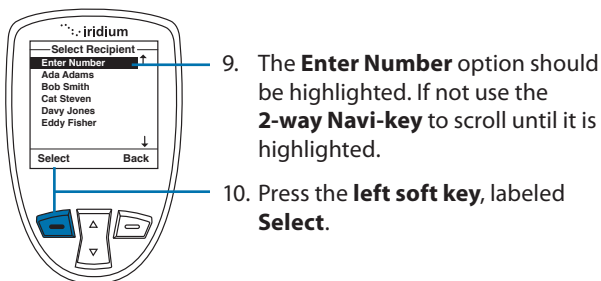
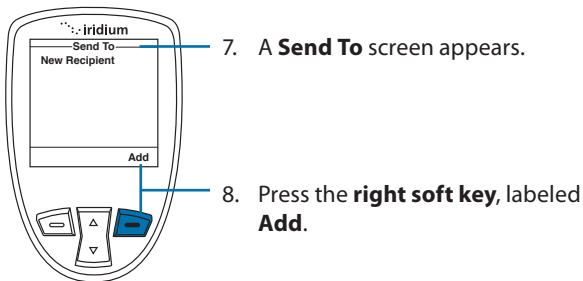

Create and Send a new SMS Message to an Email Address in My Phonebook

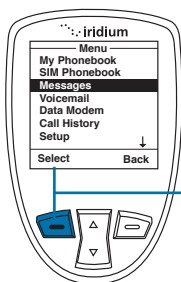

Start at the **Main Menu** with **Messages** highlighted:

1. Press the **left soft key**, labeled **Select**.

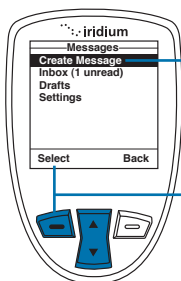

2. The **Create Message** option should be selected. If not then use the **2-way Navi-key** to scroll until it is highlighted.

3. Press the **left soft key**, labeled **Select**.

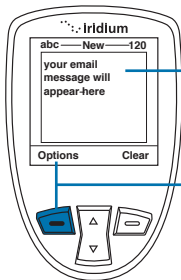

4. Enter your message.

5. When your message is complete, press the **left soft key**, labeled **Options**.

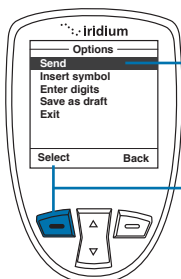

6. The **Send** option should be highlighted. If not then use the **2-way Navi-key** to scroll until it is highlighted.

7. Press the **left soft key**, labeled **Select** to send the message.

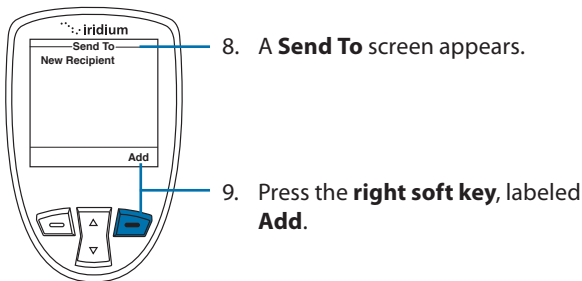

8. A **Send To** screen appears.

9. Press the **right soft key**, labeled **Add**.

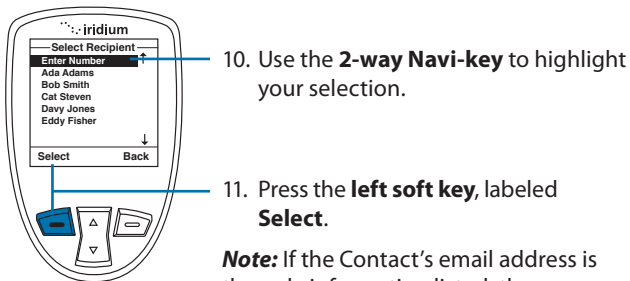

10. Use the **2-way Navi-key** to highlight your selection.

11. Press the **left soft key**, labeled **Select**.

Note: If the Contact's email address is the only information listed, the screen returns you to the **Send To** screen.

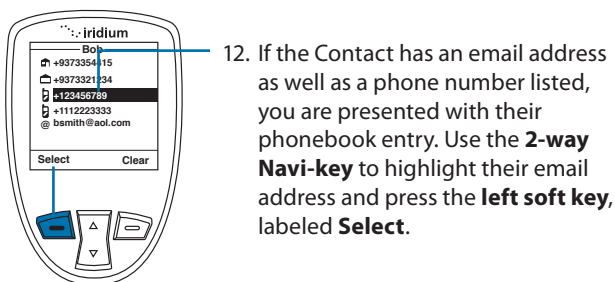

12. If the Contact has an email address as well as a phone number listed, you are presented with their phonebook entry. Use the **2-way Navi-key** to highlight their email address and press the **left soft key**, labeled **Select**.

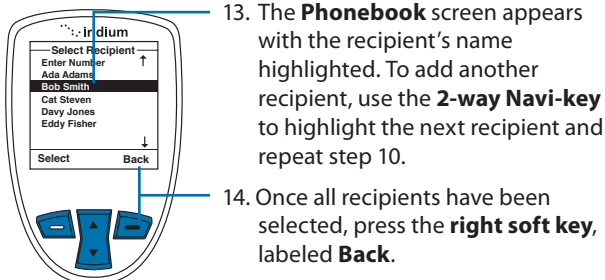

13. The **Phonebook** screen appears with the recipient's name highlighted. To add another recipient, use the **2-way Navi-key** to highlight the next recipient and repeat step 10.

14. Once all recipients have been selected, press the **right soft key**, labeled **Back**.

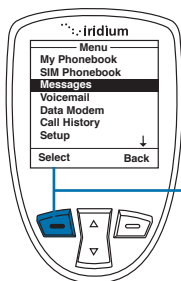

15. Press the **left soft key**, labeled **Send**.

About SMS Messaging

Message Notification

If your phone is powered ON, it notifies you of received messages in the following ways:

- An alert sounds and/or the phone vibrates.
- The message indicator is displayed
- The message **New SMS. Read Now?** is displayed.

How Messages are Stored

Your phone stores all messages on the SIM card. If the message indicator is flashing, your SIM card is full. See “Delete a Message” on page 104 to make room for the new message.

What Messages Contain

You can receive short text or numeric messages in your Personal Mailbox. Text messages may contain up to 1,000 characters. Numeric messages, typically phone numbers, may contain up to 20 digits.

Standard SMS messages are up to 160 characters. Long SMS messages up to 1000 characters are divided into smaller 160 character messages and may be billed at the standard 160 character SMS rate. For example, an SMS message with 320 characters may be billed as two standard SMS messages. Contact your service provider for additional information.

Your personal mailbox works with Call Forwarding. For more information see “Forward a Received Message” on page 101.

Using the Inbox Menu

You can do the following functions using the **Inbox** menu:

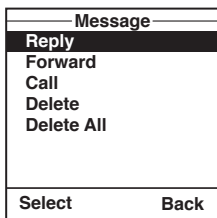

- Reply to a message
- Forward a message
- Call the number that left the message
- Delete one or all messages

Note: If the message storage space on your SIM card is full, you cannot store a message for later retrieval. See “Delete a Message” on page 104 to make room for new messages on your SIM card.

Read a Message

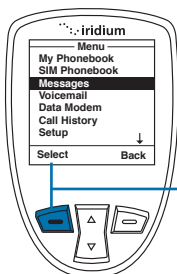

Start at the **Main Menu** with **Messages** highlighted:

1. Press the **left soft key**, labeled **Select**.

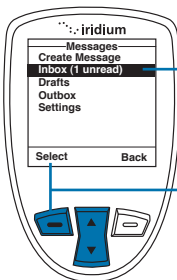

2. Use the **2-way Navi-key** to scroll until **Inbox** is highlighted.

3. Press the **left soft key**, labeled **Select**.

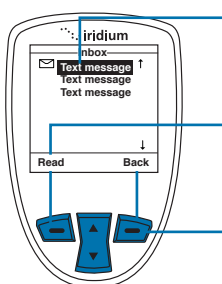

4. Use the **2-way Navi-key** to highlight a message.
5. Press the **left soft key**, labeled **Read** to view the selected message.
6. Press the **right soft key**, labeled **Back** to return to the previous menu.

Reply to Sender

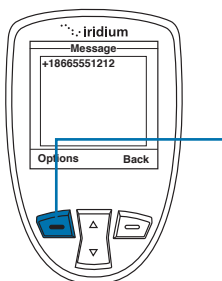

While reading the Message Screen:

1. Press the **left soft key**, labeled **Options**.

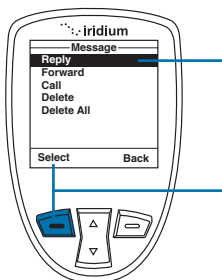

2. Use the **2-way Navi-key** to scroll until **Reply** is highlighted.
3. Press the **left soft key**, labeled **Select**.

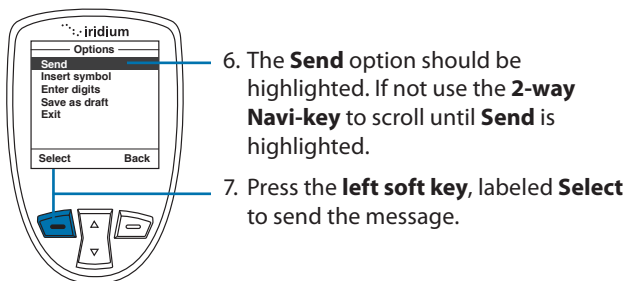
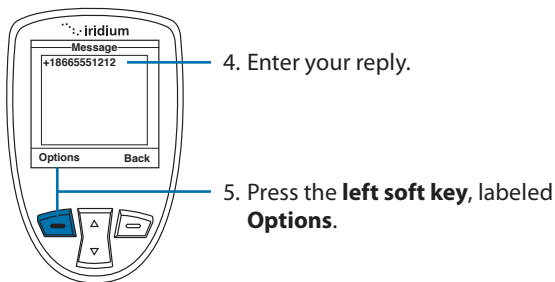

Note: If the sender's phone number is not part of your phonebook, select New Recipient to add the number.

Forward a Received Message

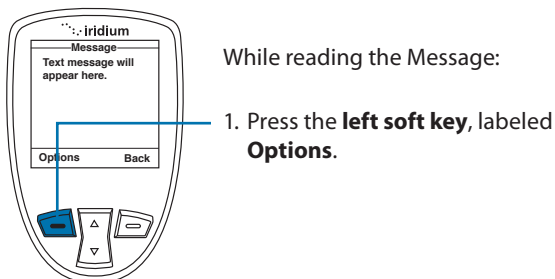

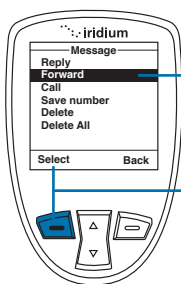

2. Use the **2-way Navi-key** to scroll until **Forward** is highlighted.

3. Press the **left soft key**, labeled **Select**.

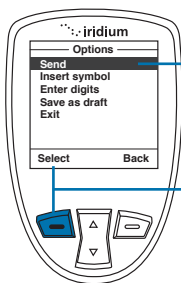

4. The **Send** option should be highlighted. If not use the **2-way Navi-key** to scroll until **Send** is highlighted.

5. Press the **left soft key**, labeled **Select** to send the message.

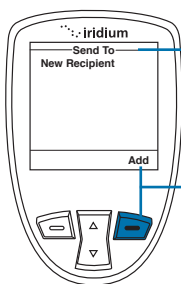

6. A **Send To** screen appears.

7. Press the **right soft key**, labeled **Add**.

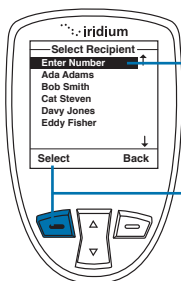

8. Use the **2-way Navi-key** until the desired recipient from your phonebook is highlighted.

9. Press the **left soft key**, labeled **Options**.

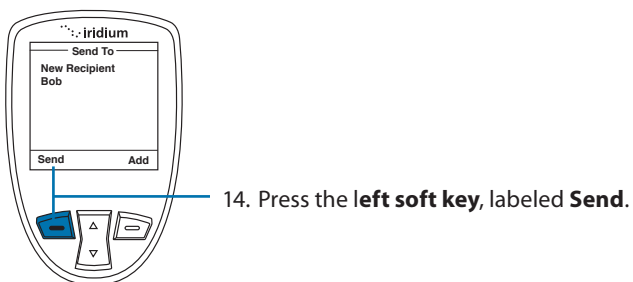
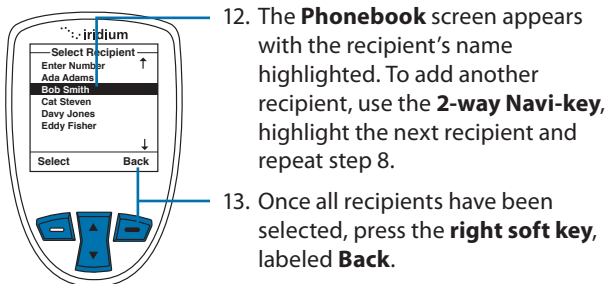
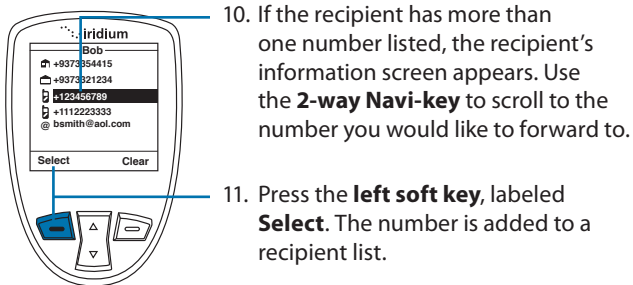

Call a Number from a Received Message

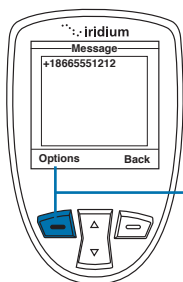

While reading the Message Screen:

1. Press the **left soft key**, labeled **Options**.

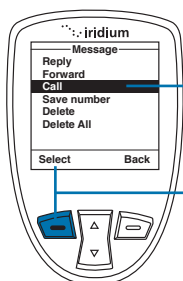

2. Use the **2-way Navi-key** to scroll until **Call** is highlighted.
3. Press the **left soft key**, labeled **Select**.

Delete a Message

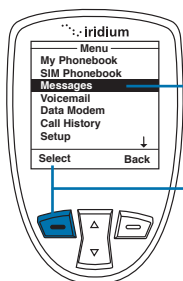

Start at the **Main Menu** with **Messages** highlighted:

1. Press the **left soft key**, labeled **Select**.

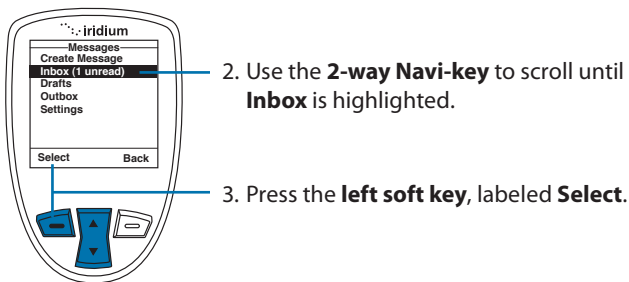

2. Use the **2-way Navi-key** to scroll until **Inbox** is highlighted.

3. Press the **left soft key**, labeled **Select**.

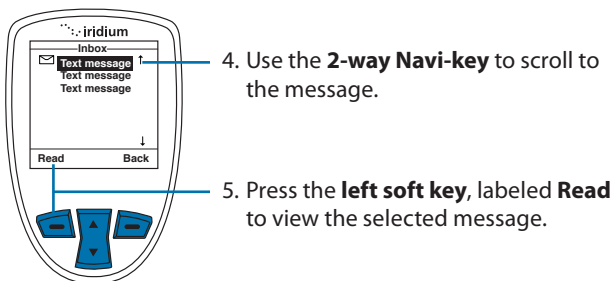

4. Use the **2-way Navi-key** to scroll to the message.

5. Press the **left soft key**, labeled **Read** to view the selected message.

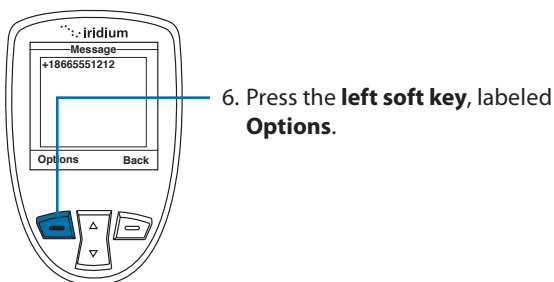

6. Press the **left soft key**, labeled **Options**.

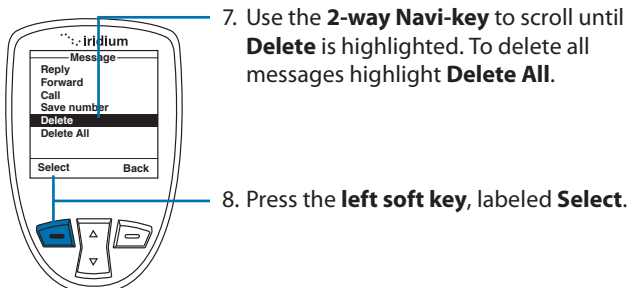

7. Use the **2-way Navi-key** to scroll until **Delete** is highlighted. To delete all messages highlight **Delete All**.

8. Press the **left soft key**, labeled **Select**.

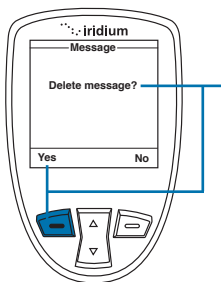

9. The Satellite Phone prompts you to ensure you want to proceed. Press the **left soft key**, labeled **Yes** to delete the message.

The screen flashes **Message Deleted**, and automatically returns to the Message mailbox.

Using the Drafts Menu

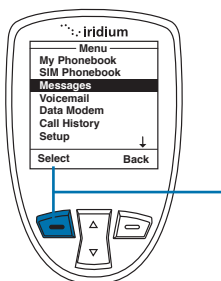

To edit and send a stored message, use the **Draft menu**. Start at the **Main Menu** with **Messages** highlighted:

1. Press the **left soft key**, labeled **Select**.

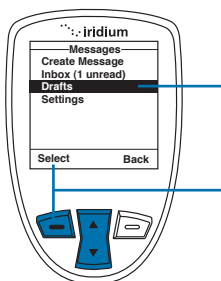

2. Use the **2-way Navi-key** to scroll until the **Drafts** option is highlighted.
3. Press the **left soft key**, labeled **Select**.

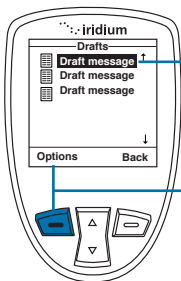

4. Use the **2-way Navi-key** to scroll until the draft message you want to send is highlighted.

5. Press the **left soft key**, labeled **Options**.

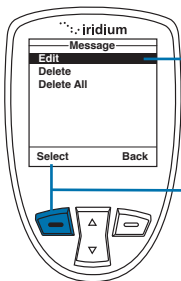

6. Highlight **Edit** and press the **left soft key**, labeled **Select**.

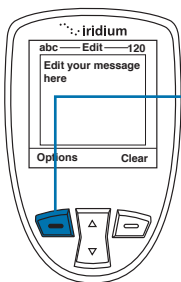

7. When you are finished editing press the **left soft key**, labeled **Options**.

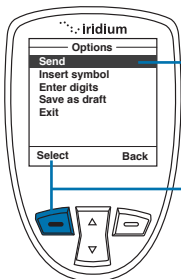

8. The **Send** option should be highlighted. If not use the **2-way Navi-key** to scroll until **Send** is highlighted.

9. Press the **left soft key**, labeled **Select** to send the message.

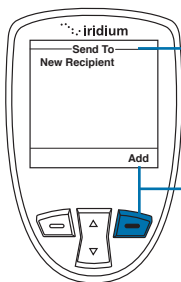

10. A **Send To** screen appears with the entry name and number.

11. Press the **right soft key**, labeled **Add**.

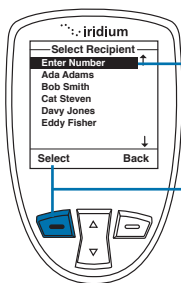

12. Use the **2-way Navi-key** until the desired recipient from your phonebook is highlighted.

13. Press the **left soft key**, labeled **Options**.

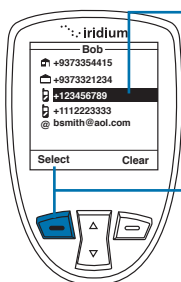

14. If the recipient has more than one number listed, the recipient's information screen appears. Use the **2-way Navi-key** to scroll to the number you would like to forward to.

15. Press the **left soft key**, labeled **Select**. The number is added to a recipient list.

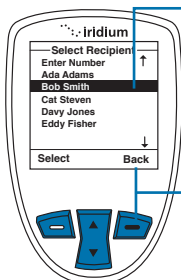

16. The **Phonebook** screen appears with the recipient's name highlighted. To add another recipient, use the **2-way Navi-key**, highlight the next recipient and repeat step 12.

17. Once all recipients have been selected, press the **right soft key**, labeled **Back**.

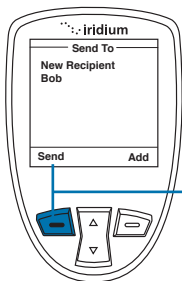

18. Press the **left soft key**, labeled **Send**.

Using the Settings Menu

Enter Service Center Number

Use this capability to enter the number for the service center to which you wish to forward your outgoing messages. The Iridium Extreme™ will use Iridium's Service Center number by default if none has been explicitly configured.

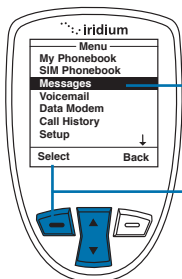

Start at the **Main Menu** with **Messages** highlighted:

1. Press the **left soft key**, labeled **Select**.

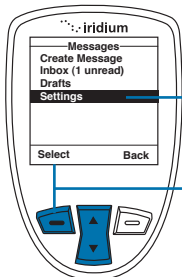

2. Use the **2-way Navi-key** to scroll until the **Settings** option is highlighted.

3. Press the **left soft key**, labeled **Select**.

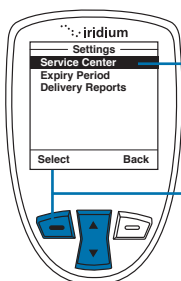

4. The **Service Center** option should be highlighted. If not use the **2-way Navi-key** to scroll until it is highlighted.

5. Press the **left soft key**, labeled **Select**.

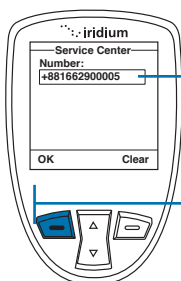

6. Enter the service number.

7. Press the **left soft key**, labeled **OK**. The screen returns to the **Settings** menu.

Set Expiry Period

Use this capability to specify the amount of time your un-delivered messages should wait before auto-expiring.

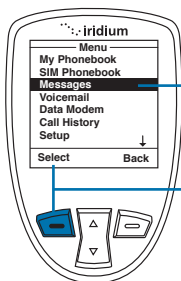

Start at the **Main Menu** with **Messages** highlighted:

1. Press the **left soft key**, labeled **Select**.

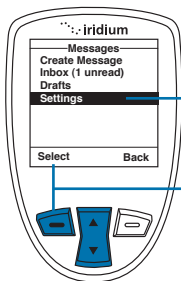

2. Use the **2-way Navi-key** to scroll until the **Settings** option is highlighted.

3. Press the **left soft key**, labeled **Select**.

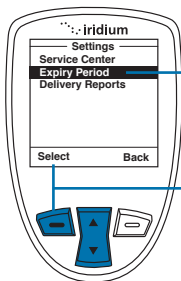

4. Use the **2-way Navi-key** to scroll until the **Expiry Period** option is highlighted.

5. Press the **left soft key**, labeled **Select**.

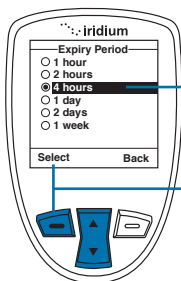

6. Use the **2-way Navi-key** to scroll until the desired period of time is highlighted.

7. Press the **left soft key**, labeled **Select**. The screen returns to the **Settings** menu.

Select Delivery Reports

Use this capability to enable or disable message delivery reports.

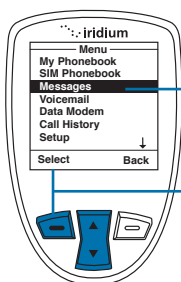

Start at the **Main Menu** with **Messages** highlighted:

1. Press the **left soft key**, labeled **Select**.

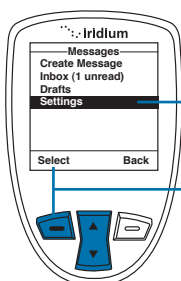

2. Use the **2-way Navi-key** to scroll until the **Settings** option is highlighted.

3. Press the **left soft key**, labeled **Select**.

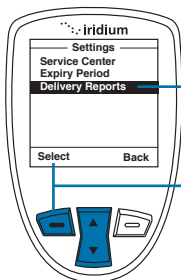

4. Use the **2-way Navi-key** to scroll until the **Delivery Reports** option is highlighted.

5. Press the **left soft key**, labeled **Select**.

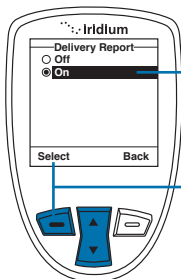

6. Use the **2-way Navi-key** to turn the **Delivery Report OFF** or **ON**.

7. Press the **left soft key**, labeled **Select**. The screen returns to the **Settings** menu.

10: Using the Voicemail Menu

Locating the Voicemail Menu

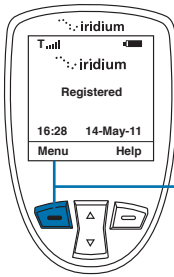

Starting from the **Main Screen**:

1. Press the **left soft key**, labeled **Menu**.

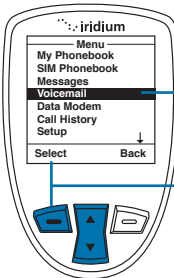

2. The **Main Menu** is displayed. Use the **2-way Navi-key** to scroll until the **Voicemail** is highlighted.

3. Press the **left soft key**, labeled **Select**.

Note: All instructions for the **Voicemail** menu start from the **Main Menu** as shown.

About the Voicemail Menu

You can do the following functions using the **Inbox** menu:

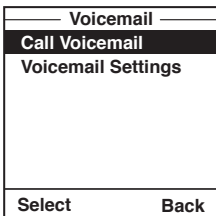

- Listen to your voicemail
- Reply to a voicemail
- Store voicemail numbers
- Access and configure your voicemail

Voicemail Notification

When you receive a voicemail, an incoming voicemail notification message automatically appears on your screen.

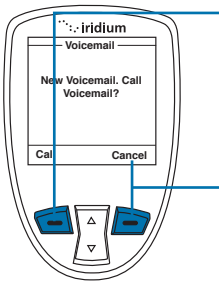

Press the **left soft key**, labeled **Call** to call and retrieve voicemail.

OR

Press the **right soft key**, labeled **Cancel**.

Check Your Voicemail

To listen to a voicemail that has been saved:

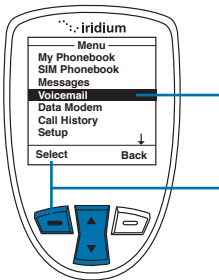

1. Use the **2-way Navi-key** to scroll until the **Voicemail** is highlighted.

2. Press the **left soft key**, labeled **Select**.

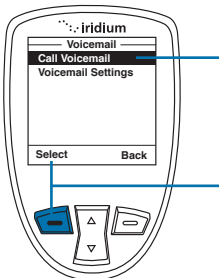

3. **Call Voicemail** is highlighted.

4. Press the **left soft key**, labeled **Select**.

Follow the audio prompts for additional capabilities.

Store Your Voicemail Number

If you have not previously stored a voicemail number, then you see No Number Available on the display. You must store a voicemail number before you can access the service for the first time.

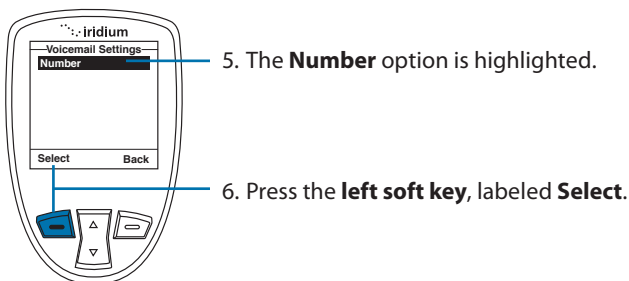
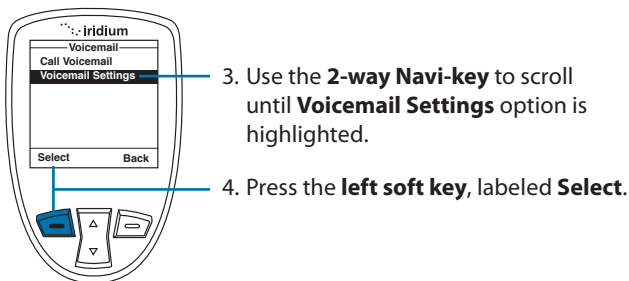
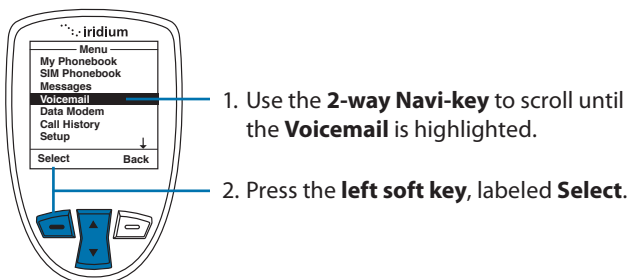

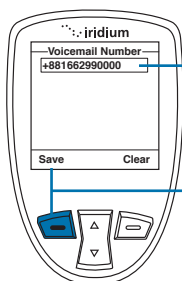

7. Enter the voicemail number given to you by your Service Provider.
8. Press the **left soft key**, labeled **Save**.

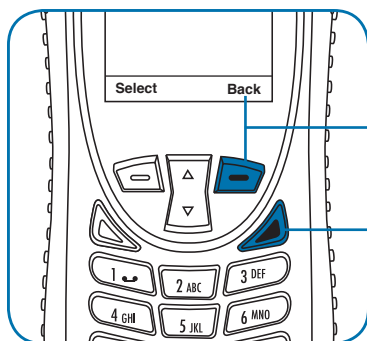

9. Press the **right soft key**, labeled **Back** to return to the previous menu.
10. Press the **red key** to exit to the **Main Screen**.

One-Touch Access to Voicemail

With the most recent software available to the Iridium Extreme™, Iridium enabled one-touch access to voicemail for ease of use. To use this new feature, ensure that you have the most recent software and press and hold the 1 key for 2 seconds in order to prompt a call to voicemail without having to navigate through the phone menu.

11: Using the Data Modem Menu

In order to use the Iridium Extreme™ as a modem for your computer, you must first follow the installation instructions provided on the CD-ROM included with your phone or use the instructions provided by your service provider. The data modem menu is not required to initiate or use the phone as a modem for data services, it only reports the connection status of the USB. The instructions provided are optional and are to be followed if desired prior to plugging in the USB cable to the phone and to your computer.

Locating the Data Modem Menu

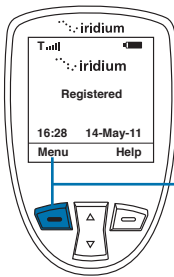

Starting from the **Main Screen**:

1. Press the **left soft key**, labeled **Menu**.

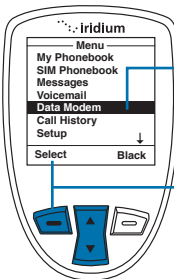

2. The **Main Menu** is displayed. Use the **2-way Navi-key** to scroll until **Data Modem** is highlighted.
3. Press the **left soft key**, labeled **Select**.

Note: All instructions for the **Data Modem** menu start from the **Main Menu** as shown.

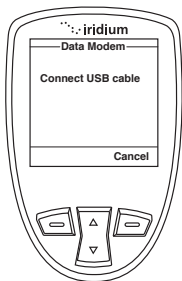

Note: If you are not connected to the USB cable you are prompted to connect. While connected to the USB cable it is important to not remove the battery.

If you need to remove the battery, first disconnect from the USB cable, power down the Iridium Extreme™ and then remove the battery.

12: Using the Call History Menu

Locating the Call History Menu

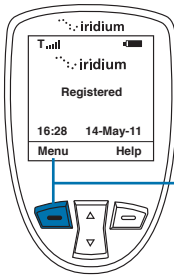

Starting from the **Main Screen**:

1. Press the **left soft key**, labeled **Menu**.

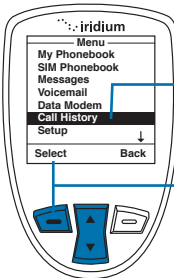

2. The **Main Menu** is displayed. Use the **2-way Navi-key** to scroll until **Call History** is highlighted.
3. Press the **left soft key**, labeled **Select**.

Note: All instructions for the **Call History** menu start from the **Main Menu** as shown.

About the Call History Menu

You can perform the following functions using the **Call History** menu:

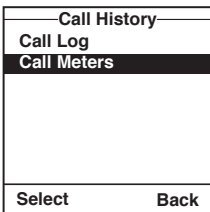

- View the amount of time spent talking on your phone
- View your most recent dialed, missed and received calls
- Set phone alerts

Using the Call Log Menu

View Most Recent Received Calls

Your phone saves received calls. Use the **Call Log** menu to view those numbers.

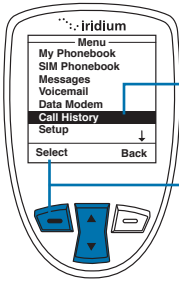

Starting from the **Main Menu**:

1. Use the **2-way Navi-key** to scroll until **Call History** is highlighted.
2. Press the **left soft key**, labeled **Select**.

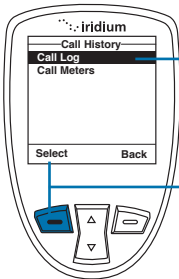

3. The **Call History** menu is displayed with **Call Log** highlighted.
4. Press the **left soft key**, labeled **Select**.

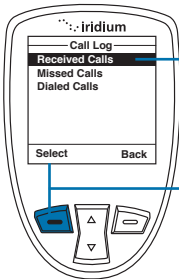

5. The **Call Log** menu is displayed with **Received Calls** highlighted.
6. Press the **left soft key**, labeled **Select**.

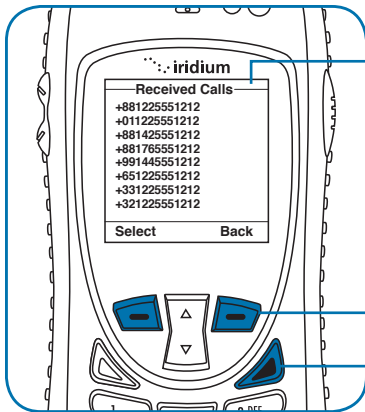

7. The **Received Calls** screen is displayed with a list of your last ten calls. Inbound Caller ID to provide specific numbers is not currently supported by the network. This feature may be enabled in the future.

Press the **right soft key** labeled **Back** to go back one level, or the **red key** to return the **Main Screen**.

View Missed Calls

Your phone saves a list of calls you've missed when the phone is busy or were not able to get to it. The phone does not show calls that you missed when the phone is turned OFF or not registered on the network.

Starting from the **Main Menu**:

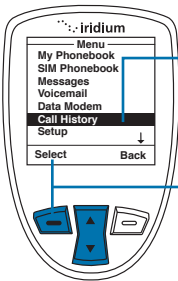

1. Use the **2-way Navi-key** to scroll until **Call History** is highlighted.

2. Press the **left soft key**, labeled **Select**.

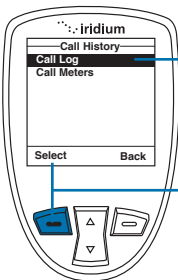

3. The **Call History** menu is displayed with **Call Log** highlighted.

4. Press the **left soft key**, labeled **Select**.

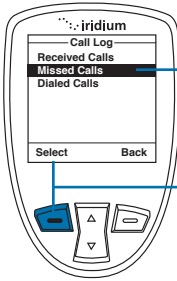

5. Using the **2-way Navi-key** scroll until **Missed Calls** is highlighted.
6. Press the **left soft key**, labeled **Select**.

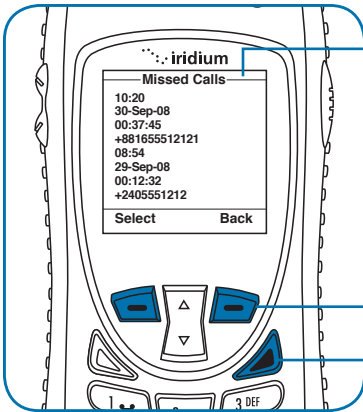

7. The **Missed Calls** screen is displayed with a list of your last missed calls. Inbound Caller ID to provide specific numbers is not currently supported by the network. This feature may be enabled in the future

Press the **right soft key** labeled **Back** to go back one level, or the **red key** to return the **Main Screen**.

View Most Recent Dialed Calls

Your phone saves the last ten calls dialed. Use the Call Log menu to view those numbers.

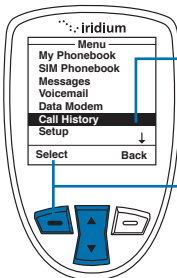

Starting from the **Main Menu**:

1. Use the **2-way Navi-key** to scroll until **Call History** is highlighted.
2. Press the **left soft key**, labeled **Select**.

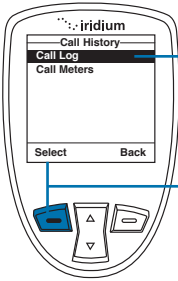

3. The **Call History** menu is displayed with **Call Log** highlighted.

4. Press the **left soft key**, labeled **Select**.

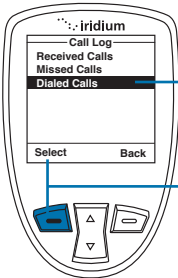

5. Using the **2-way Navi-key** scroll until **Dialed Calls** is highlighted.

6. Press the **left soft key**, labeled **Select**.

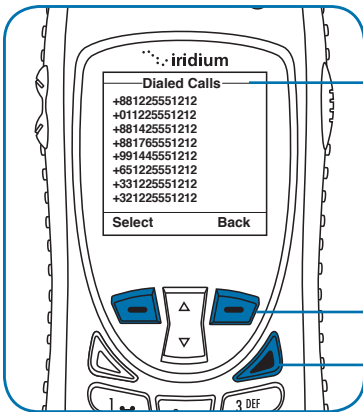

7. The **Dialed Calls** screen is displayed with a list of your last ten calls.

Press the **right soft key** labeled **Back** to go back one level, or the **red key** to return the **Main Screen**.

Using the Call Meters Menu

Call meters help you track your airtime, keep a running tab of your monthly usage or view the air time of your most recent calls.

Show the Time of Last Call

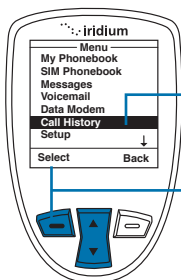

Starting from the **Main Menu**:

1. Use the **2-way Navi-key** to scroll until **Call History** is highlighted.
2. Press the **left soft key**, labeled **Select**.

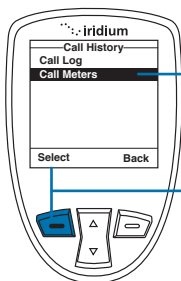

3. Use the **2-way Navi-key** to scroll until **Call Meters** is highlighted.
4. Press the **left soft key**, labeled **Select**.

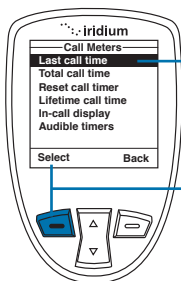

5. **Last call time** is highlighted. If not, use the **2-way Navi-key** until it is.
6. Press the **left soft key**, labeled **Select**.

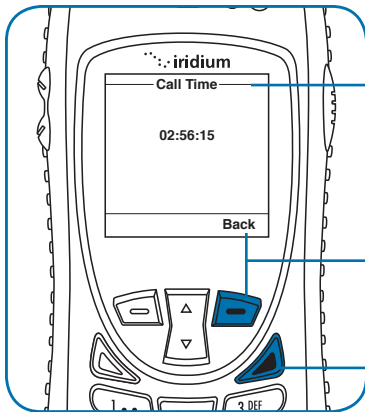

The duration of the last call is displayed.

7. Press the **right soft key** labeled **Back** to return to the previous menu.

8. Press the **red key** to return to the **Main Screen**.

Note: The last call timer shows the elapsed time of the most recent call made since your phone was turned on. This information is not saved when you turn off the phone.

Show Total Time for All Calls

This capability displays your total airtime since you last reset the call timer.

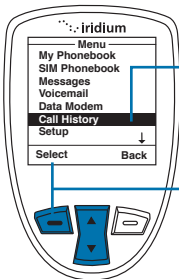

Starting from the **Main Menu**:

1. Use the **2-way Navi-key** to scroll until **Call History** is highlighted.

2. Press the **left soft key**, labeled **Select**.

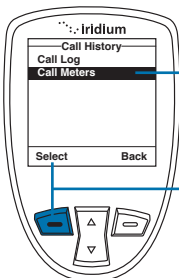

3. Use the **2-way Navi-key** to scroll until **Call Meters** is highlighted.

4. Press the **left soft key**, labeled **Select**.

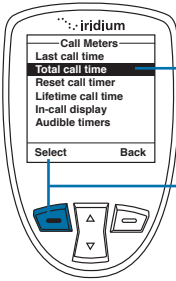

5. Use the **2-way Navi-key** to scroll until **Total call time** is highlighted.
6. Press the **left soft key**, labeled **Select**.

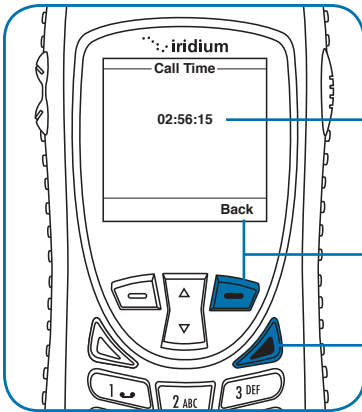

- The airtime accumulation since the timer was last reset is displayed on the screen.
7. Press the **right soft key** labeled **Back** to return to the previous menu.
8. Press the **red key** to return to the **Main Screen**.

Reset all Timers

Reset your timers at the beginning of each billing cycle to keep track of your spending.

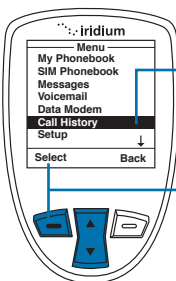

- Starting from the **Main Menu**:
1. Use the **2-way Navi-key** to scroll until **Call History** is highlighted.
 2. Press the **left soft key**, labeled **Select**.

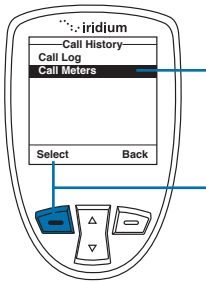

3. Use the **2-way Navi-key** to scroll until **Call Meters** is highlighted.

4. Press the **left soft key**, labeled **Select**.

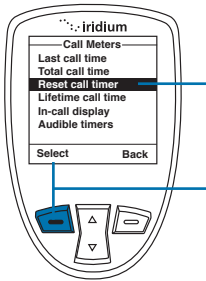

5. Use the **2-way Navi-key** to scroll until **Reset call timer** is highlighted.

6. Press the **left soft key**, labeled **Select**.

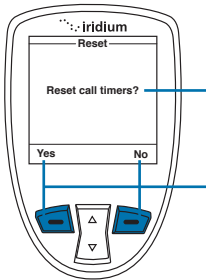

The screen displays: **Reset call timers?**

7. Press the **left soft key** for **Yes** or the **right soft key** for **No**.

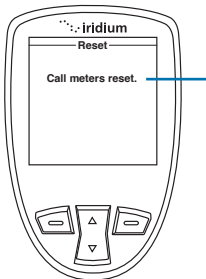

8. If you press **Yes**, the display reads **Call meters reset**.

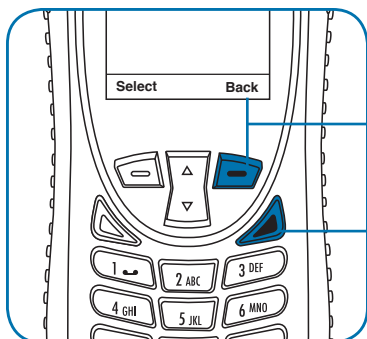

9. Press the **right soft key** labeled **Back** to return to the previous menu.
10. Press the **red key** to return to the **Main Screen**.

Showing the Lifetime Call Timer

This capability displays a running clock of the total call time for the phone since being activated.

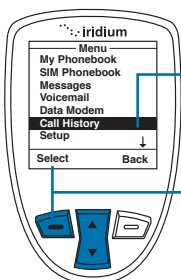

Starting from the **Main Menu**:

1. Use the **2-way Navi-key** to scroll until **Call History** is highlighted.
2. Press the **left soft key**, labeled **Select**.

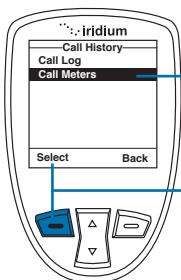

3. Use the **2-way Navi-key** to scroll until **Call Meters** is highlighted.
4. Press the **left soft key**, labeled **Select**.

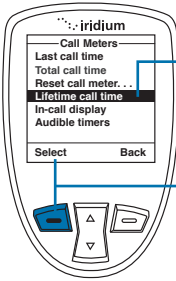

3. Use the **2-way Navi-key** to scroll until **Call Meters** is highlighted.
4. Press the **left soft key**, labeled **Select**.

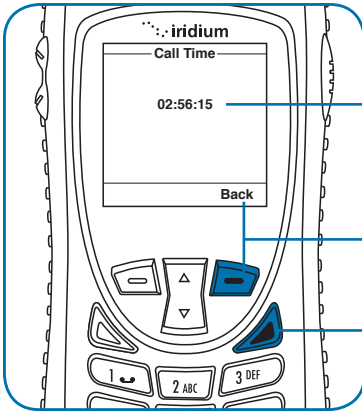

6. The total time of all calls is displayed.
7. Press the **right soft key** labeled **Back** to return to the previous menu.
8. Press the **red key** to return to the **Main Screen**.

Note: The Lifetime timer can not be reset.

Showing the In-call Display

This capability enables or disables the call timer that displays the amount of time that has passed since placing a specific call.

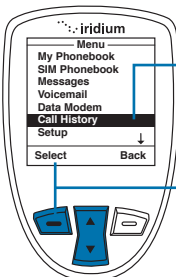

Starting from the **Main Menu**:

1. Use the **2-way Navi-key** to scroll until **Call History** is highlighted.
2. Press the **left soft key**, labeled **Select**.

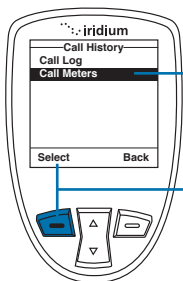

3. Use the **2-way Navi-key** to scroll until **Call Meters** is highlighted.

4. Press the **left soft key**, labeled **Select**.

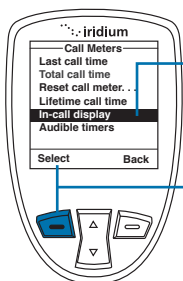

5. Use the **2-way Navi-key** to scroll until **In-call display** is highlighted.

6. Press the **left soft key**, labeled **Select**.

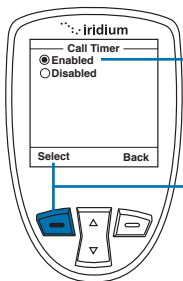

7. Use the **2-way Navi-key** to scroll to **Enabled** or **Disabled**.

8. Press the **left soft key**, labeled **Select**.

Setting Audible Call Timers

This capability lets the phone watch the clock for you. At a set time or interval, the call timers produce a beep that only you can hear. You can choose No Alert, Single Alert or Repetitive Alert.

Set the Single Alert Timer

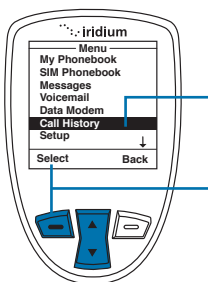

Starting from the **Main Menu**:

1. Use the **2-way Navi-key** to scroll until **Call History** is highlighted.
2. Press the **left soft key**, labeled **Select**.

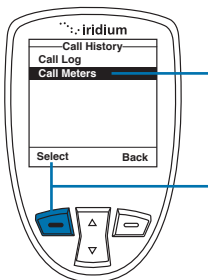

3. Use the **2-way Navi-key** to scroll until **Call Meters** is highlighted.
4. Press the **left soft key**, labeled **Select**.

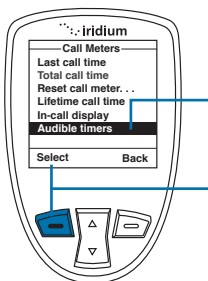

5. Use the **2-way Navi-key** to scroll until **Audible timers** is highlighted.
6. Press the **left soft key**, labeled **Select**.

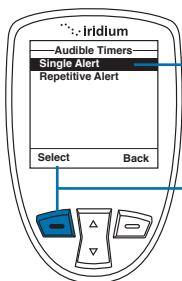

7. The **Single Alert** option should be highlighted. If not, use the **2-way Navi-key** to scroll until it is.

8. Press the **left soft key**, labeled **Select**.

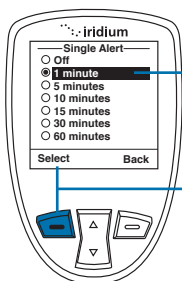

9. Use the **2-way Navi-key** to scroll to the desired single alert.

10. Press the **left soft key**, labeled **Select**.

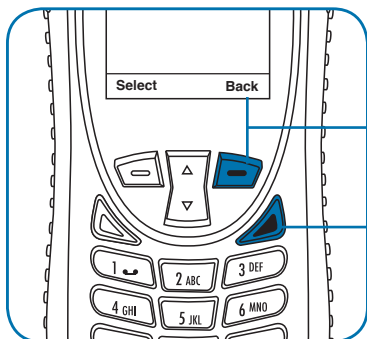

11. Press the **right soft key** labeled **Back** to return to the previous menu.

12. Press the **red key** to return to the **Main Screen**.

Set the Repetitive Alert

This capability sets your phone to alert you at specific intervals, for example every minute.

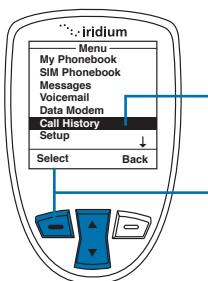

Starting from the **Main Menu**:

1. Use the **2-way Navi-key** to scroll until **Call History** is highlighted.

2. Press the **left soft key**, labeled **Select**.

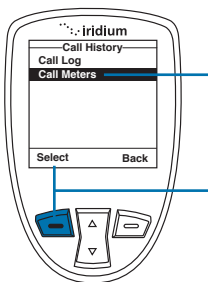

3. Use the **2-way Navi-key** to scroll until **Call Meters** is highlighted.

4. Press the **left soft key**, labeled **Select**.

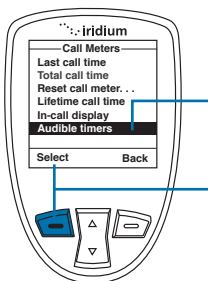

5. Use the **2-way Navi-key** to scroll until **Audible timers** is highlighted.

6. Press the **left soft key**, labeled **Select**.

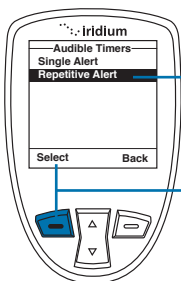

7. Use the **2-way Navi-key** to scroll to the **Repetitive Alert** option.
8. Press the **left soft key**, labeled **Select**.

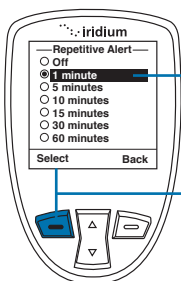

9. Use the **2-way Navi-key** to scroll to the desired repetitive alert.
10. Press the **left soft key**, labeled **Select**.

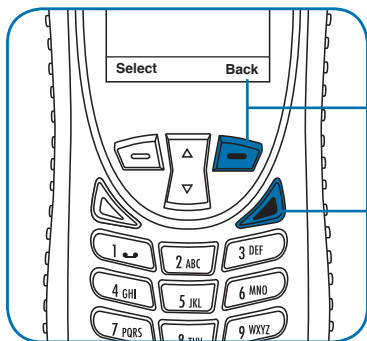

11. Press the **right soft key** labeled **Back** to return to the previous menu.
12. Press the **red key** to return to the **Main Screen**.

13: Using the Setup Menu

Locating the Setup Menu

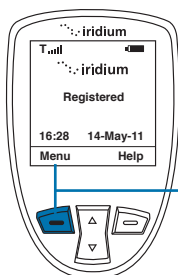

Starting from the **Main Screen**:

1. Press the **left soft key**, labeled **Menu**.

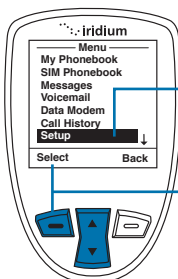

2. The **Main Menu** is displayed. Use the **2-way Navi-key** to scroll until **Setup** is highlighted.

3. Press the **left soft key**, labeled **Select**.

Note: All instructions for the **Setup** menu start from the **Main Menu** as shown.

About the Setup Menu

You can perform the following functions using the **Setup** menu:

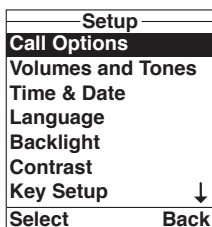

- Set call options
- Set volumes and tones for your ringer speaker and alert
- Set time zone, time and date format
- Set language
- Set your phone lighting preferences
- Set the contrast on the display screen

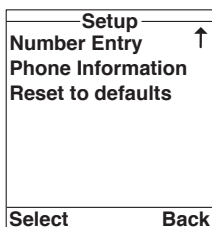

- Set preference for the convenience key and right soft key
- Set your prefix preference for entering phone numbers
- View phone information
- Reset phone settings to default

Note: The Setup menu consists of two screens. Scroll past the Key Setup option for more menu options.

Setting Call Options

The Call Options menu allows you to enable or disable various call capabilities.

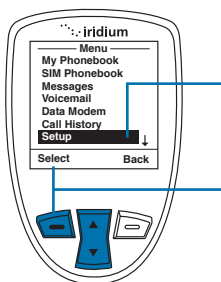

Starting from the **Main Menu**:

1. Use the **2-way Navi-key** to scroll until **Setup** is highlighted.
2. Press the **left soft key**, labeled **Select**.

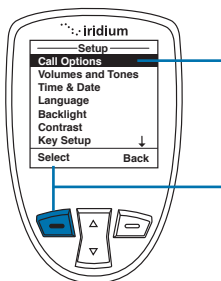

3. **Call Options** is already displayed.
4. Press the **left soft key**, labeled **Select**.

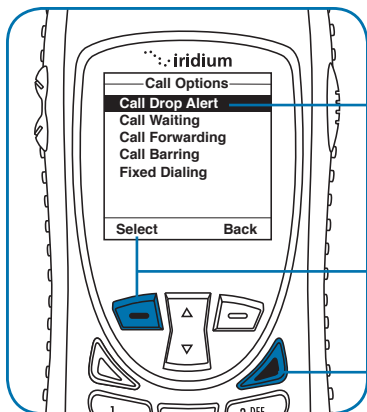

5. Highlight the call capability you would like to enable.

6. Press the **left soft key** labeled **Select** to return to the previous menu.

7. Press the **red key** to return to the **Main Screen**.

Setting Volumes and Tones

Adjust the Ringer Volume

The **Volumes and Tones** menu allows you to adjust your phone's ringer volume and tone, and set the phone to ring or vibrate to notify you of incoming calls.

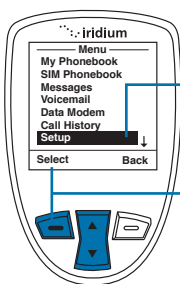

Starting from the **Main Menu**:

1. Use the **2-way Navi-key** to scroll until **Setup** is highlighted.

2. Press the **left soft key**, labeled **Select**.

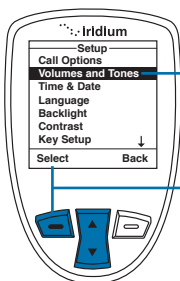

3. Use the **2-way Navi-key** to scroll until **Volumes and Tones** is highlighted.

4. Press the **left soft key**, labeled **Select**.

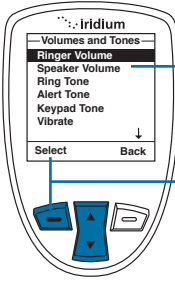

5. **Ringer Volume** is highlighted. If not, use the **2-way Navi-key** to scroll to it.
6. Press the **left soft key**, labeled **Select**.

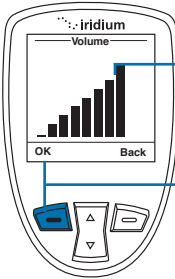

7. The volume bars increase or decrease as you press the **2-way Navi-key** up or down.
8. Press the **left soft key**, labeled **OK** when you have the desired setting.

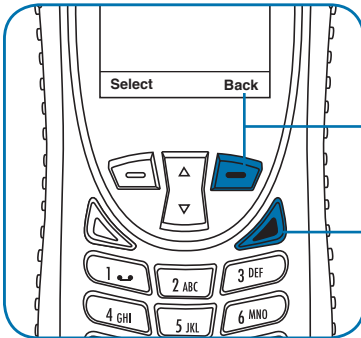

9. Press the **right soft key** labeled **Back** to return to the previous menu.
10. Press the **red key** to return to the **Main Screen**.

Adjust the Speaker Volume

This capability adjusts the volume of the speaker. The phone sounds the new volume level as you adjust it.

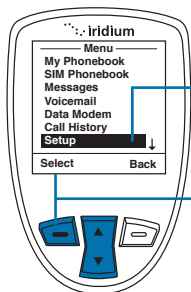

Starting from the **Main Menu**:

1. Use the **2-way Navi-key** to scroll until **Setup** is highlighted.

2. Press the **left soft key**, labeled **Select**.

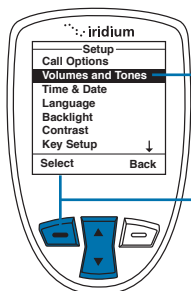

3. Use the **2-way Navi-key** to scroll until **Volumes and Tones** is highlighted.

4. Press the **left soft key**, labeled **Select**.

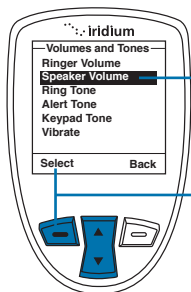

5. Use the **2-way Navi-key** to scroll to **Speaker Volume**.

6. Press the **left soft key**, labeled **Select**.

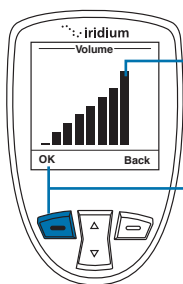

7. The volume bars increase or decrease as you press the **2-way Navi-key** up or down.
8. Press the **left soft key**, labeled **OK** when you have the desired setting.

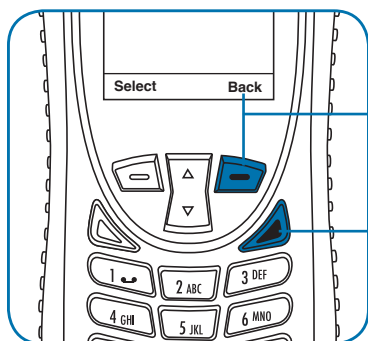

9. Press the **right soft key** labeled **Back** to return to the previous menu.
10. Press the **red key** to return to the **Main Screen**.

Adjust the Ring Tone

This capability adjusts the tone of the ringer. The phone sounds the new tone as you adjust it.

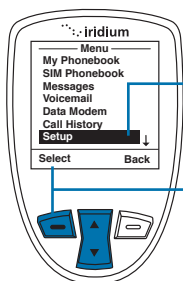

Starting from the **Main Menu**:

1. Use the **2-way Navi-key** to scroll until **Setup** is highlighted.
2. Press the **left soft key**, labeled **Select**.

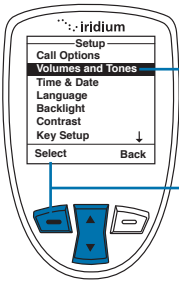

3. Use the **2-way Navi-key** to scroll until **Volumes and Tones** is highlighted.

4. Press the **left soft key**, labeled **Select**.

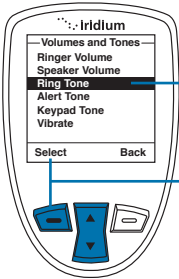

5. Use the **2-way Navi-key** to scroll to **Speaker Volume**.

6. Press the **left soft key**, labeled **Select**.

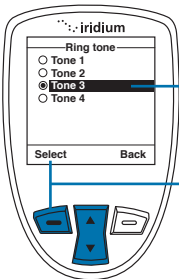

7. Use the **2-way Navi-key** to scroll to the desired tone

8. Press the **left soft key**, labeled **Select**.

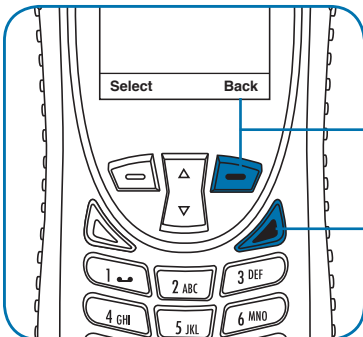

9. Press the **right soft key** labeled **Back** to return to the previous menu.

10. Press the **red key** to return to the **Main Screen**.

Setting the Call Alert Mode

This capability adjusts the alert tone. The phone sounds the new tone as you adjust it.

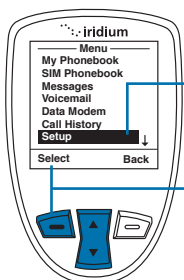

Starting from the **Main Menu**:

1. Use the **2-way Navi-key** to scroll until **Setup** is highlighted.

2. Press the **left soft key**, labeled **Select**.

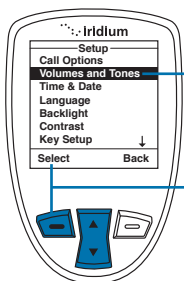

3. Use the **2-way Navi-key** to scroll until **Volumes and Tones** is highlighted.

4. Press the **left soft key**, labeled **Select**.

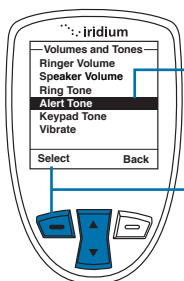

5. Use the **2-way Navi-key** to scroll until **Alert Tone** is highlighted.

6. Press the **left soft key**, labeled **Select**.

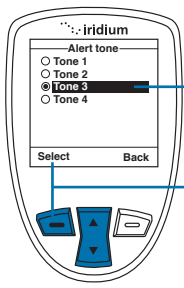

- 7. Use the **2-way Navi-key** to scroll to the desired tone.
- 8. Press the **left soft key**, labeled **Select**.

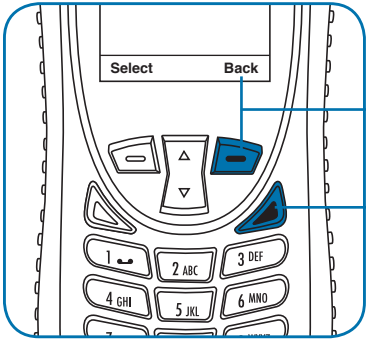

- 9. Press the **right soft key** labeled **Back** to return to the previous menu.
- 10. Press the **red key** to return to the **Main Screen**.

Setting the Keypad Tone

This capability selects the keypad tone. You can select to have a single tone, DTMF tones or no tones when the keypad is pressed.

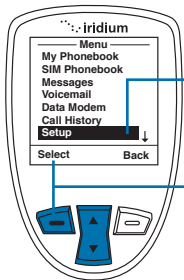

- Starting from the **Main Menu**:
- 1. Use the **2-way Navi-key** to scroll until **Setup** is highlighted.
 - 2. Press the **left soft key**, labeled **Select**.

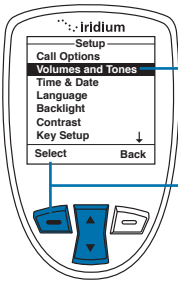

3. Use the **2-way Navi-key** to scroll until **Volumes and Tones** is highlighted.

4. Press the **left soft key**, labeled **Select**.

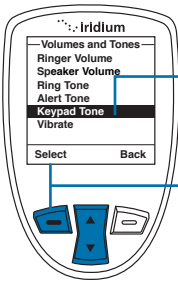

5. Use the **2-way Navi-key** to scroll until **keypad Tone** is highlighted.

6. Press the **left soft key**, labeled **Select**.

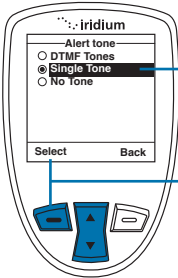

7. Use the **2-way Navi-key** to scroll to the desired tone.

8. Press the **left soft key**, labeled **Select**.

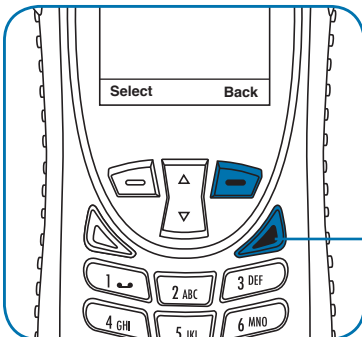

9. Press the **right soft key** labeled **Back** to return to the **Main Screen**.

Set the Phone to Ring and /or Vibrate

This capability is ideal for situations where a ringing phone is inappropriate or in a loud environment. The vibrate function notifies you of incoming calls with discreet vibrations.

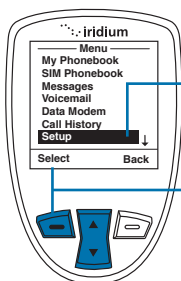

Starting from the **Main Menu**:

1. Use the **2-way Navi-key** to scroll until **Setup** is highlighted.
2. Press the **left soft key**, labeled **Select**.

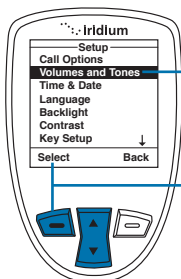

3. Use the **2-way Navi-key** to scroll until **Volumes and Tones** is highlighted.
4. Press the **left soft key**, labeled **Select**.

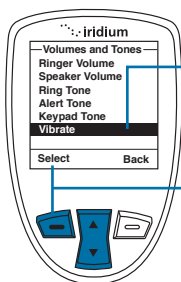

5. Use the **2-way Navi-key** to scroll until **Vibrate** is highlighted.
6. Press the **left soft key**, labeled **Select**.

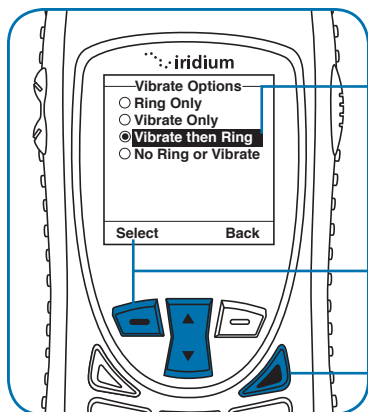

7. Use the **2-way Navi-key** to scroll to the desired **Vibrate** Option.

8. Press the **left soft key**, labeled **Select**.

9. Press the **right soft key** labeled **Back** to return to the **Main Screen**.

Time and Date Settings

Select the Time Zone

Your phone uses the satellite network to obtain the time and date information. However, you need to select the time zone in which you are located.

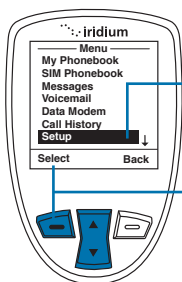

Starting from the **Main Menu**:

1. Use the **2-way Navi-key** to scroll until **Setup** is highlighted.

2. Press the **left soft key**, labeled **Select**.

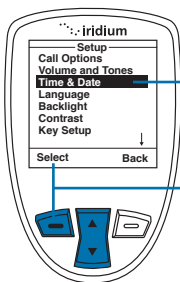

3. Use the **2-way Navi-key** to scroll until **Time & Date** is highlighted.

4. Press the **left soft key**, labeled **Select**.

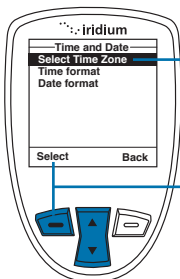

5. Use the **2-way Navi-key** to scroll until **Time Zone** is highlighted.

6. Press the **left soft key**, labeled **Select**.

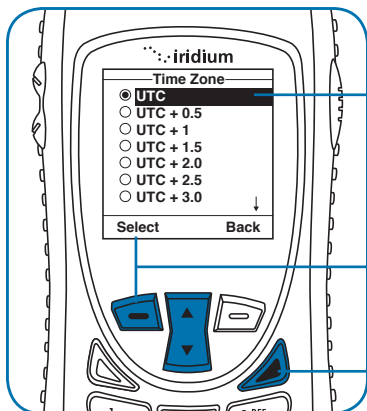

7. Use the **2-way Navi-key** until the required time zone is highlighted.

8. Press the **left soft key**, labeled **Select**.

9. Press the **right soft key** labeled **Back** to return to the **Main Screen**.

Select the Time Format

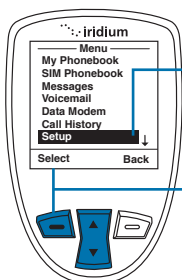

Starting from the **Main Menu**:

1. Use the **2-way Navi-key** to scroll until **Setup** is highlighted.
2. Press the **left soft key**, labeled **Select**.

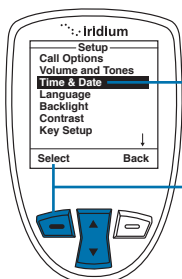

3. Use the **2-way Navi-key** to scroll until **Time & Date** is highlighted.
4. Press the **left soft key**, labeled **Select**.

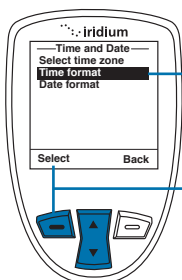

5. Use the **2-way Navi-key** to scroll until **Time Zone** is highlighted.
6. Press the **left soft key**, labeled **Select**.

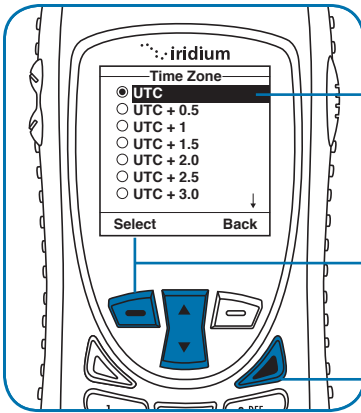

7. Use the **2-way Navi-key** until the required time zone is highlighted.
8. Press the **left soft key**, labeled **Select**.
9. Press the **right soft key** labeled **Back** to return to the **Main Screen**.

Select the Date Format

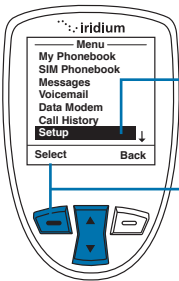

Starting from the **Main Menu**:

1. Use the **2-way Navi-key** to scroll until **Setup** is highlighted.
2. Press the **left soft key**, labeled **Select**.

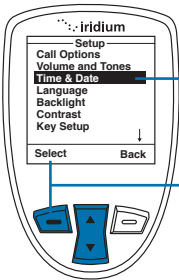

3. Use the **2-way Navi-key** to scroll until **Time & Date** is highlighted.
4. Press the **left soft key**, labeled **Select**.

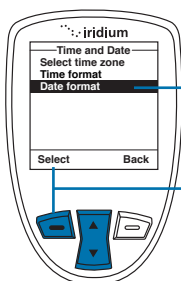

5. Use the **2-way Navi-key** to scroll until **Date Format** is highlighted.
6. Press the **left soft key**, labeled **Select**.

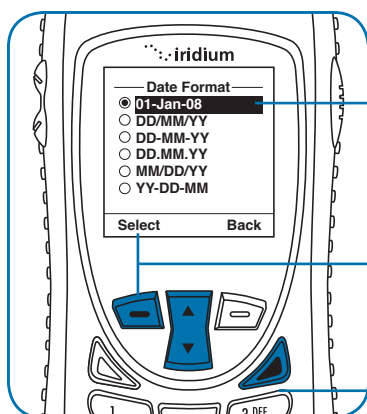

7. Use the **2-way Navi-key** until the required date format is highlighted.
8. Press the **left soft key**, labeled **Select**.
9. Press the **right soft key** labeled **Back** to return to the **Main Screen**.

Selecting the Display Language

Your phone contains 21 languages. Use this capability to select the language in which your phone displays menus and messages.

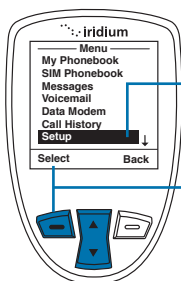

Starting from the **Main Menu**:

1. Use the **2-way Navi-key** to scroll until **Setup** is highlighted.
2. Press the **left soft key**, labeled **Select**.

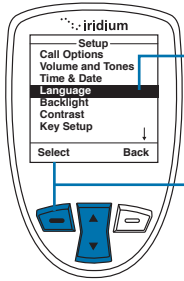

3. Use the **2-way Navi-key** to scroll until **Language** is highlighted.
4. Press the **left soft key**, labeled **Select**.

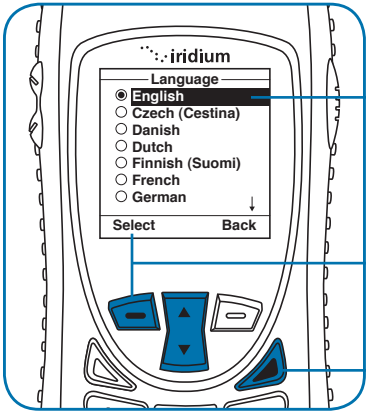

5. Use the **2-way Navi-key** to scroll until the required **Language** is highlighted.
6. Press the **left soft key**, labeled **Select**.
7. Press the **right soft key** labeled **Back** to return to the **Main Screen**.

Tip: If you accidentally select a language other than English and are unable to reset your phone, follow these steps:

1. Press the **left soft key**.
2. Scroll down six times.
3. Press the **left soft key** again.
4. Scroll down three times
5. Press the **left soft key**, the **English** option is at the top.

Setting Backlights

Enable, disable or adjust the length of time the backlight stays on after a key press.

Starting from the **Main Menu**:

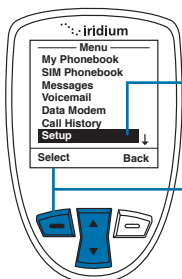

1. Use the **2-way Navi-key** to scroll until **Setup** is highlighted.

2. Press the **left soft key**, labeled **Select**.

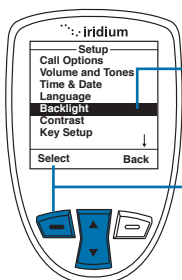

3. Use the **2-way Navi-key** to scroll until **Backlight** is highlighted.

4. Press the **left soft key**, labeled **Select**.

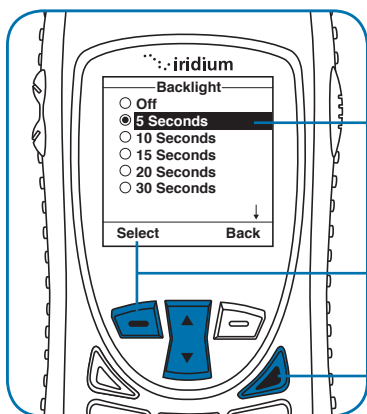

5. Use the **2-way Navi-key** to scroll until the required **Backlight** is highlighted.

6. Press the **left soft key**, labeled **Select**.

7. Press the **right soft key** labeled **Back** to return to the **Main Screen**.

Setting Contrast

This capability allows you to adjust the contrast on the display screen.

Starting from the **Main Menu**:

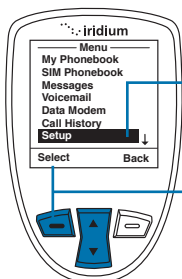

1. Use the **2-way Navi-key** to scroll until **Setup** is highlighted.

2. Press the **left soft key**, labeled **Select**.

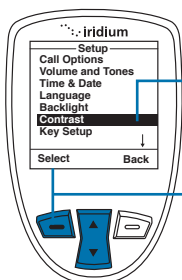

3. Use the **2-way Navi-key** to scroll until **Contrast** is highlighted.

4. Press the **left soft key**, labeled **Select**.

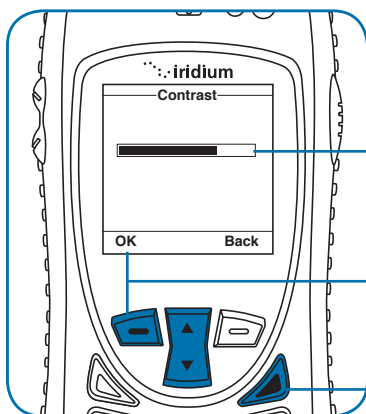

5. Use the **2-way Navi-key** to scroll until to increase or decrease the contrast.

6. Press the **left soft key**, labeled **Select**.

7. Press the **right soft key** labeled **Back** to return to the **Main Screen**.

Using the Key Setup Menu

This capability selects the function of the **convenience key** and the **right soft key** when the **Main Screen** is displayed. The default function is to display the Help screen which is useful for new users; however the function can be changed to access the phonebook.

Setup the Convenience Key Function

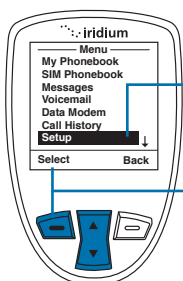

Starting from the **Main Menu**:

1. Use the **2-way Navi-key** to scroll until **Setup** is highlighted.

2. Press the **left soft key**, labeled **Select**.

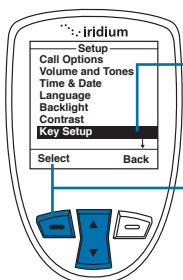

3. Use the **2-way Navi-key** to scroll until **Key Setup** is highlighted.

4. Press the **left soft key**, labeled **Select**.

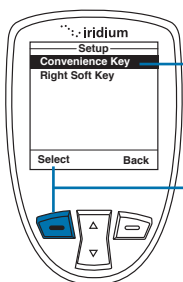

5. **Convenience Key** is highlighted.

6. Press the **left soft key**, labeled **Select**.

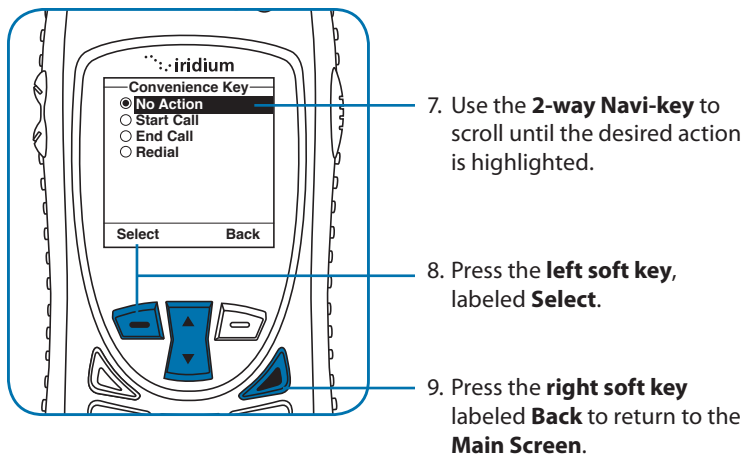

Setup the Right Soft Key Function

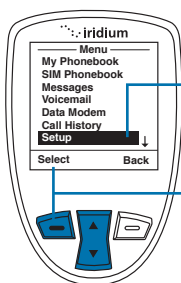

Starting from the **Main Menu**:

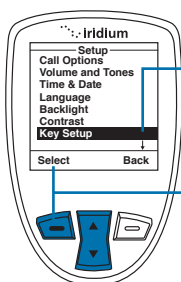

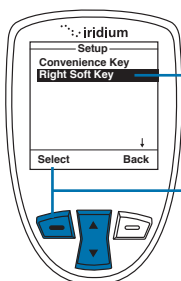

5. Use the **2-way Navi-key** until **Right Soft Key** is highlighted.

6. Press the **left soft key**, labeled **Select**.

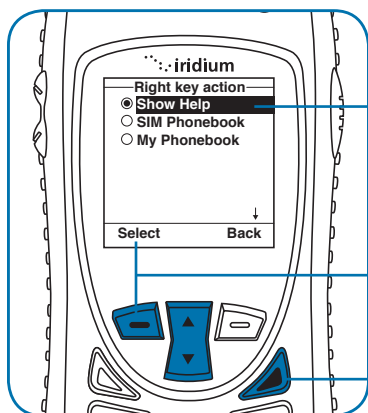

7. Use the **2-way Navi-key** to scroll until the desired action is highlighted.

8. Press the **left soft key**, labeled **Select**.

9. Press the **right soft key** labeled **Back** to return to the **Main Screen**.

Set Number Entry Prefix

This capability allows you to set your preferred international access code and can automatically attach (00) or (+) to any phone number you enter.

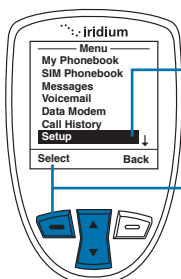

Starting from the **Main Menu**:

1. Use the **2-way Navi-key** to scroll until **Setup** is highlighted.

2. Press the **left soft key**, labeled **Select**.

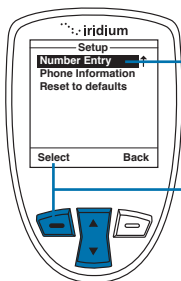

- Use the **2-way Navi-key** to scroll past the **Key Setup** option until **Number Entry** is highlighted.
- Press the **left soft key**, labeled **Select**.

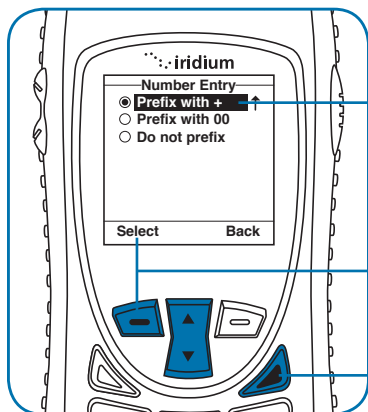

- Use the **2-way Navi-key** to scroll until the desired action is highlighted.
- Press the **left soft key**, labeled **Select**.
- Press the **right soft key** labeled **Back** to return to the **Main Screen**.

View Phone Information

This capability allows you to view technical information about the Iridium Extreme™ Satellite Phone software, hardware versions and the IMEI number.

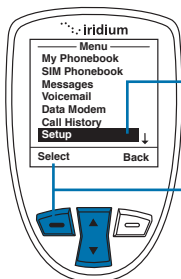

Starting from the **Main Menu**:

- Use the **2-way Navi-key** to scroll until **Setup** is highlighted.
- Press the **left soft key**, labeled **Select**.

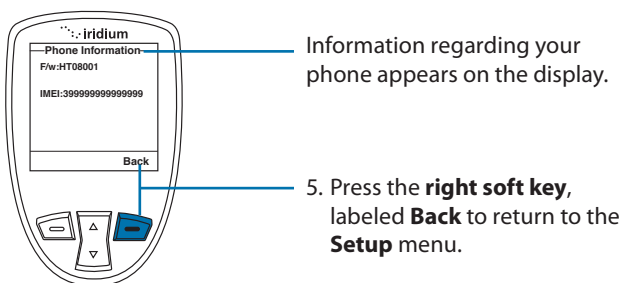
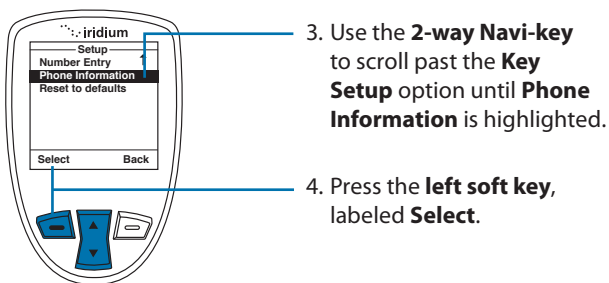

Reset Phone Options to Factory Defaults

This capability resets all settings to their original default settings.

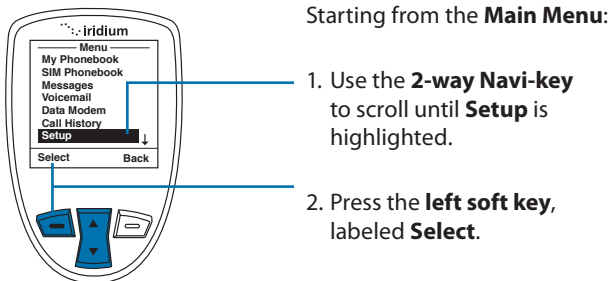

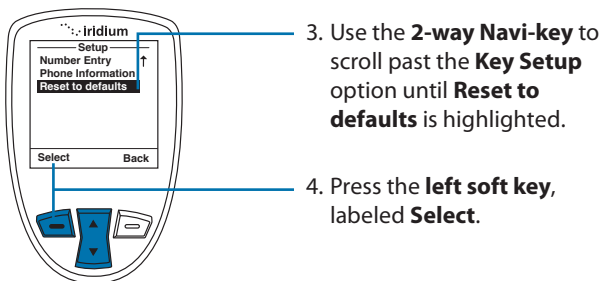

3. Use the **2-way Navi-key** to scroll past the **Key Setup** option until **Reset to defaults** is highlighted.

4. Press the **left soft key**, labeled **Select**.

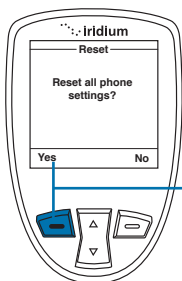

5. Press the **left soft key**, labeled **Select**.

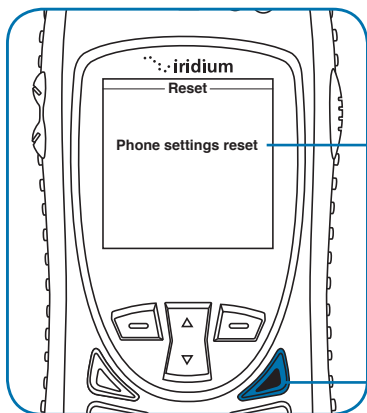

6. A message appears briefly indicating the phone settings have been reset.

7. Press the **red key** to return to the **Main Screen**.

14: GPS and Location-Based Services

The Iridium Extreme™ GPS and Location-Based Service features allow you to view, send, or restrict your location information. There are four main components to setup and use these features:

- **Location Options Setup Menu:** located in the Iridium Extreme™ main menu in the setup section, Location Options Options is where you customize your GPS, emergency, message, and format options.
- **Programmable SOS button:** this red button is located on the top of the phone, under a protective cover. By removing the cover and pressing the red button you can send your location information to your designated contact in the event of an emergency.
- **Location Convenience Key:** located on the right side of the phone, you can press this key to view your location and share it via SMS to either a pre-programmed “Quick GPS” contacts or a new message contact.
- **Online portal integration with 3rd party providers:** enables the transmission of the phone’s location information on a scheduled interval via short-burst data (SBD) to 3rd party portal providers for online tracking

Note: Standard usage fees apply for sharing location via messaging or placing a phone call via the programmable SOS button.

Location Options Setup Menu

The Location Options Setup Menu enables you to set up the following options:

- **GPS Options:** Enable/disable GPS on your handset; determine how frequently the GPS is updated when enabled; and lock your GPS settings.
- **Emergency Options:** Set up **Emergency Recipients**; determine **Emergency Actions**; configure **Emergency settings**; and enter/cancel **Emergency Mode**.
- **Message Options:** Set up the recipient and frequency of your auto GPS location update message.
- **Format:** Configure the format of GPS location information.
- **Current Location:** View and update your current GPS location.

Locating Location Options

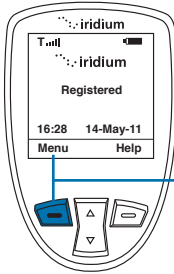

Starting from the **main screen**:

1. Press the **left soft key**, labeled **Menu**.

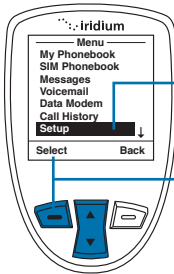

2. The **Main Menu** is displayed. Use the **2-way Navi-key** to scroll until **Setup** is highlighted.

Press the **left soft key** to select **Setup**.

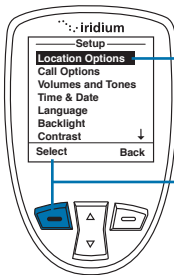

3. With **Location Options** highlighted press the **left soft key**, labeled **Select** to enter the **Location Options** menu.



4. Within the **Location Options** menu are **GPS Options**, **Emergency Options**, **Message Options**, **Format**, and **Current Location**.

Using the GPS Options Menu

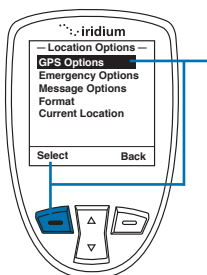

Use the **GPS Options** menu to configure the basic GPS settings on your handset. Through this menu you can lock GPS settings, set the GPS refresh frequency rate, and turn GPS On or Off.

1. Press the **left soft key**, labeled **Select**

GPS Settings Lock

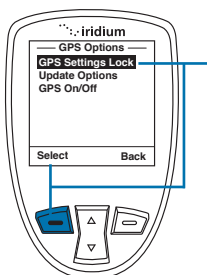

Within the **GPS Options** menu, enable the **GPS Settings Lock** to prevent modifications to GPS settings unless the **GPS Settings Lock PIN** is entered.

1. Press the **left soft key**, labeled **Select**.

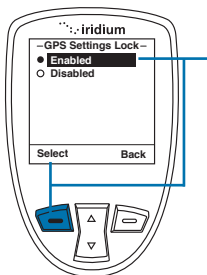

The default setting for **GPS Settings Lock** is **Disabled**. To enable **GPS Settings Lock**, move the **2-way Navi-key** until the **Enabled** option is highlighted

2. Press the **left soft key**, labeled **Select**.

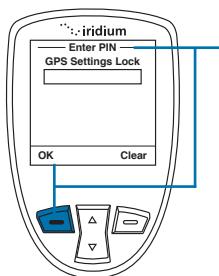

To modify the **GPS Settings Lock**, you will be prompted to enter the **GPS Settings Lock PIN**. The default **GPS Settings Lock PIN** is **3333** and can be modified in the **Security Menu** by navigating to **Change PINs** and then **GPS Settings Lock**.

3. Once the default or personalized **GPS Settings Lock PIN** is entered, press the left soft key, labeled **OK**.

GPS Update Options

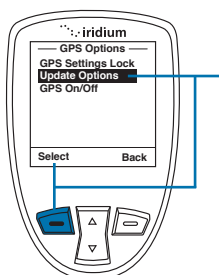

Within the **GPS Options** menu, the **GPS Update Options** will allow you to set how frequently a GPS position is updated for viewing the **Current Location** on the phone screen. To access **Update Options**, use the **2-way Navi-key** to scroll and highlight this feature.

1. Press the **left soft key**, labeled **Select**.

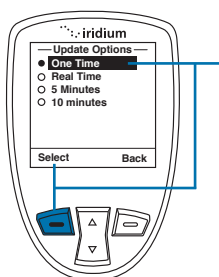

Within the **Update Options** menu, the options are provided to have the GPS location updated **One Time**, **Real Time**, every **5 minutes**, or every **10 minutes**. To modify this setting, use the **2-way Navi-key** to scroll and highlight the desired update rate.

2. Press the **left soft key**, labeled **Select**.

Turning GPS On/Off

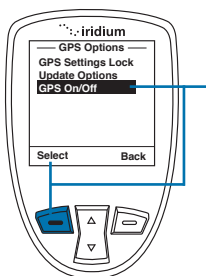

Within the **GPS Options** menu, the **GPS On/Off** will allow you to turn the built-in GPS receiver on or off in your phone. Features that require GPS on will prompt you to turn GPS on. Use of the programmable SOS button will automatically turn GPS on. To adjust **GPS On/Off**, access the **GPS Options** menu and use the **2-way Navi-key** until the **GPS On/Off** menu is selected.

1. Press the **left soft key**, labeled **Select**.

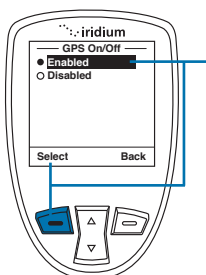

The default setting for **GPS On/Off** is **Disabled**, meaning that GPS is off. It is recommended that GPS is enabled for frequent use of GPS (for example, use with 3rd party online tracking portal) and disabled for infrequent use to conserve battery. To **Enable GPS** and turn it on, use the **2-way Navi-key** until the **Enabled** option is highlighted.

2. Press the **left soft key**, labeled **Select**.

Note: the GPS receiver automatically saves your location to your phone when the phone is turned on even if the GPS receiver is off.

Setting Emergency Options

The Emergency Options menu items are used to personalize your settings for the programmable SOS button located on the top of your phone. The programmable SOS button gives you the ability to flip open the protective SOS button cover, press the red key located underneath, and initiate a message and/or phone call to your dedicated contacts. These contacts could be a family member, commercial safety service, safety office, or Iridium-supported public emergency number (ex. 911 in U.S. or 000 in Australia).

Note: the operation of the SOS button feature is limited by any conditions affecting the GPS signal strength and GPS service availability.

CAUTION: you must configure the SOS button Emergency Mode contact in order to send an emergency message to a designated emergency call recipient.

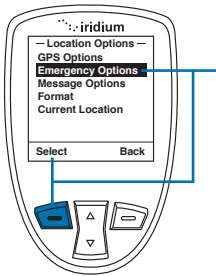

To access **Emergency Options**, access **Location Options** and scroll down with the **2-way Navi-key** until **Emergency Options** is highlighted.

Press the **left soft key**, labeled **Select**.

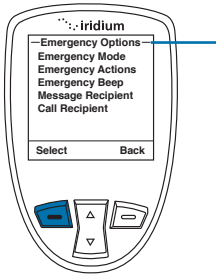

Within the **Emergency Options** menu are **Emergency Mode**, **Emergency Actions**, **Emergency Beep**, **Message Recipient**, and **Call Recipient**.

Emergency Mode

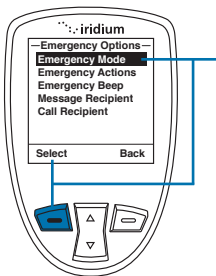

In the Emergency Options menu, the Emergency Mode allows you to initiate an emergency call and/or message to your programmed contacts. The more direct way to initiate Emergency Mode is to press the red SOS button located on the top of your phone.

If Emergency Mode is active, this menu item can be used to cancel Emergency Mode. When Emergency Mode is activated, the option to cancel Emergency

To initiate **Emergency Mode** from the menu, highlight "**Emergency Mode**" and press the **left soft key**, labeled **Select**.

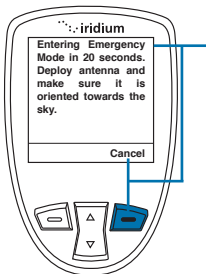

After selecting **Enter Emergency Mode** the countdown screen appears. You will have 20 seconds to press the right soft key labeled **Cancel** to stop **Emergency Mode** if initiated accidentally. This feature is designed to help reduce false notifications to your designated emergency contacts.

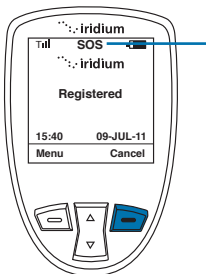

Once in **Emergency Mode** the phone will initiate a call and/or message to your designated contacts. The phone call (if programmed) will occur in speakerphone mode and will retry if the attempted call is unsuccessful.

Additionally, the phone (if programmed) will send an SMS message to your designated contact every five minutes in the following format:

```
EMERGENCY Lat+38.950116 (stdv 0075) Lon-0.250050 (stdv 0075)Alt -964
ft (stdv 0075) GPS sats 00 2011-05-24 13:06UTC Batt 49% User lang en Sent
via Iridium
```

This message contains the following information:

- EMERGENCY notification
- The Latitude and standard deviation for accuracy
- The Longitude and standard deviation for accuracy
- The Altitude and standard deviation for accuracy
- The number of GPS satellites that were visible to the phone to assist with gauging accuracy
- The date (year – month – day) and time (UTC)
- The % of phone battery charge remaining
- The language of the phone menu setting to give some indication of the language of the user (ex. "en" is English)
- Sent via Iridium

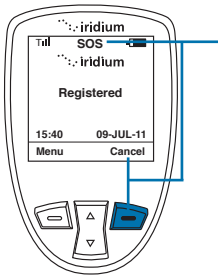

While in **Emergency Mode** the dedicated **SOS LED** will illuminate and **SOS icon** on the phone screen will appear. The **SOS LED** will change colors from red to green depending upon the transmission status and an audible tone will also occur (if programmed) when the **Emergency Mode** message is being sent.

Emergency Mode can be cancelled by pressing the **right soft key**, labeled **Cancel**.

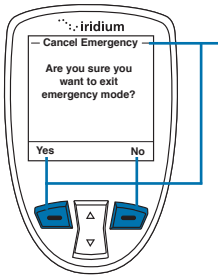

If you decide to **cancel Emergency Mode**, the phone will prompt you with a message asking you if **“Are you sure you want to exit emergency mode?”** If you select **“No”** by pressing the **right soft key**, labeled **No**, **Emergency Mode** will not be cancelled. If you select **“Yes”** by pressing the **left soft key** labeled **“Yes”**, **Emergency Mode** will be cancelled. If **Emergency Mode** is canceled, a cancellation message will be sent to your designated contact.

Note: if you do not cancel **Emergency Mode**, your phone will continue to remain in **Emergency Mode** even after you turn off and on the phone.

Emergency Actions

In the **Emergency Options** menu, **Emergency Actions** will allow you to determine the types of call and/or message actions that will occur when **Emergency Mode** is initiated. The default setting is **Message and Call**, which means that a message and call will be initiated to your programmed contacts in the event that **Emergency Mode** is started by pressing the red SOS button on the top of the phone or by selecting Emergency Mode from the menu.

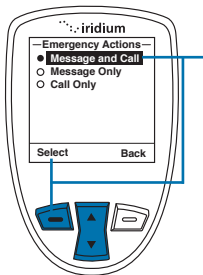

To change the default setting to either **Message Only** or **Call Only**, use the **2-way Navi-key**, highlight the preferred option and press the **left option key**, labeled **Select**.

Note: If the **GPS Settings Lock** is enabled, you will be prompted for the **GPS Settings Lock PIN** when attempting to change this setting.

Emergency Beep

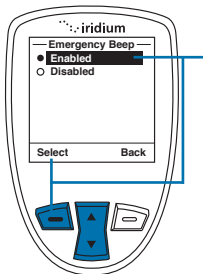

In the **Emergency Options** menu, if **Emergency Beep** is enabled, the handset will beep three (3) times every five (5) minutes to enable responders to hear where the handset is located. The default setting is **Disabled**. To change the default setting to **Enabled**, use the **2-way Navi-key** to highlight **Enabled** and press the **left option key**, labeled **Select**.

Note: If the **GPS Settings Lock** is enabled, you will be prompted for the **GPS Settings Lock PIN** when attempting to change this setting.

Message Recipient

In the **Emergency Options** menu, **Message Recipient** will allow you to program up to three (3) contacts that will receive **Emergency Mode** notifications via messaging. In order for this feature to operate, "**Message and Call**" or "**Message Only**" needs to be selected in **Emergency Actions**.

The default setting for **Message Recipient** is "empty", meaning that recipients need to be added in order to notify a designated contact in the event of an emergency.

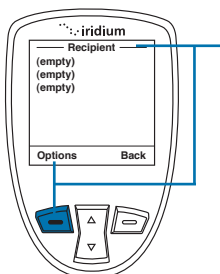

To program a new **Message Recipient**, use the **2-way Navi-key** and highlight the listing that you would like to **Edit** or **Delete**. Press the **left option key**, labeled **Options**.

Note: If the GPS Settings Lock is enabled, you will be prompted for the GPS Settings Lock PIN when attempting to change this setting.

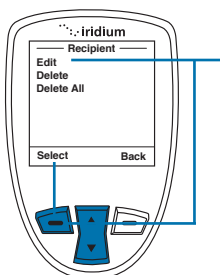

Next, use the **2-way Navi-key** to highlight the desired option to **Edit**, **Delete**, or **Delete All**. If **Edit** is selected, the phone will allow you to Edit or enter a new message recipient. If **Delete** is selected, it will delete the previously highlighted **Message Recipient** listing. If **Delete All** is selected, **all Message Recipient listings** will be deleted.

Once the desired action is highlighted using the **2-way Navi-key**, press the **left option key**, labeled **Select**.

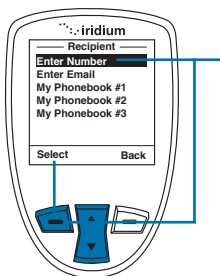

Next, if **Edit** is selected, the **Select Recipient** screen will appear providing the options to **Enter Number**, **Enter Email**, or select an existing address from your Phonebook.

- To **Enter Number**, press the **left option key**, labeled **Select**, and enter the number.
- To **Enter Email**, use the **2-way Navi-key** to highlight **Enter Email** and press the **left option key**, labeled **Select**.
- To select an existing address, use the **2-way Navi-key** to highlight the **My**

Phonebook listing and press the **left option key**, labeled **Select**.

Once the **My Phonebook** listing is selected, you will need to use the **2-way Navi-key** to highlight which address to use and then press the left option key, labeled **Select**.

Once your recipient has been added, it will appear in your **Message Recipient** listing.

Call Recipient

In the **Emergency Options** menu, **Call Recipient** will allow you to program one (1) contact that will receive an **Emergency Mode** phone call. In order for this feature to operate, "**Message and Call**" or "**Phone Only**" needs to be selected in **Emergency Actions**.

The default setting for **Message Recipient** is blank, meaning that a call recipient needs to be added in order to notify a designated contact in the event of an emergency.

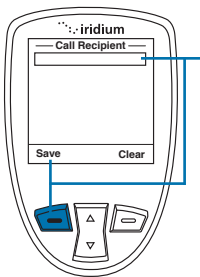

To program a new **Call Recipient**, type in the desired number and press the **left soft key**, labeled **Save**.

Note: a + sign is automatically added at the beginning of the dialing string to automatically insert the international access code, therefore 00 is not required. The call recipient number must include the country code and number (ex. +12125551212) or emergency number (ex. +911). Note that Iridium only supports 911 in the US and 000 in Australia and these numbers will not work in other geographies.

Message Options

In the **Location Options** menu, **Message Options** will allow you to program settings for **Regular Updates** of location and also use of a **Quick GPS** list feature.

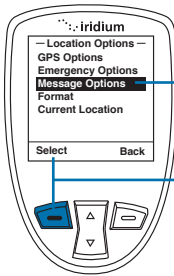

To program **Message Options**, press the **left soft key**, labeled **Select**.

In the **Message Options** menu, **Regular Updates** will allow you to program one (1) recipient to receive regularly scheduled messages from you with your location. Once the recipient is programmed and a message frequency is selected, your designated contact will receive **Regular Updates** from you automatically.

Quick GPS will allow you to send one (1) single location update to up to five (5) recipients programmed in your phone via messaging. To initiate a **Quick GPS**, press the **Convenience Key** located on the right side of your phone, obtain an updated location, select “**Share**” with the **left option key**, and select **Quick GPS** with the **left option key**.

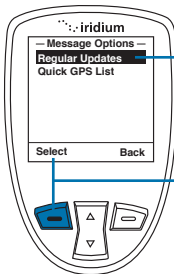

To program the **Regular Updates** from the **Message Options** screen, select **Regular Updates** with the **left option key**, labeled **Select**. Once selected, **Update Frequency** and **Update Recipient** will appear.

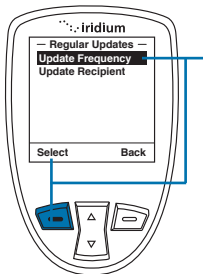

- To modify the **Update Frequency**, press the **left option key**, labeled **Select**. The default setting is **No Update**, meaning that no update message will be sent. The options are: **No update, Startup only, 5 minutes, 10 minutes, 30 minutes, 1 hour, 4 hours, 8 hours, 12 hours, 18 hours, 1 day, 3 days, 1 week**.
- To modify the default setting, use the **2-way Navi-key**, highlight the desired option and press the **left option key**, labeled **Select**.
- To modify the **Update Recipient**, use the **2-way Navi-key** to highlight **Update Recipient** and press the **left option key**, labeled **Select**.

After selecting **Update Recipient**, you will see one empty listing for programming. Press the **left option key**, labeled **Options** in order to **Edit**, **Delete**, or **Delete All** of the **Update Recipient** listing. Next, if **Edit** is selected, the **Select Recipient** screen will appear providing the options to **Enter Number**, **Enter Email**, or select an existing address from your **Phonebook**.

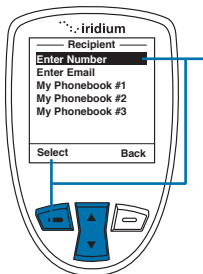

- To **Enter Number**, press the left option key, labeled **Select**, and enter the number.
- To **Enter Email**, use the **2-way Navi-key** to highlight **Enter Email** and press the **left option key**, labeled **Select**.
- To select an **existing address**, use the **2-way Navi-key** to highlight the **My Phonebook** listing and press the **left option key**, labeled **Select**. Once the **My Phonebook** listing is selected,

you will need to use the **2-way Navi-key** to highlight which address to use and then press the **left option key**, labeled **Select**.

Once your recipient has been added, it will appear in your **Update Recipient** listing.

GPS Quick List

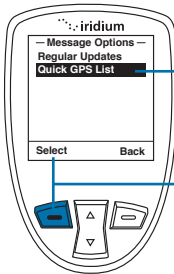

To program the **Quick GPS List** from the Message Options screen, use the **2-way Navi-key** and select **Quick GPS List** with the **left option key**, labeled **Select**. Once selected, five (5) empty listings will appear. To add a **new recipient**, highlight the empty listing that you would like to change and press the **left option key**, labeled **Select**. To **Enter Number**, **Enter Email**, or select an existing address from your **phonebook**, follow the same instructions as programming an **Update Recipient** as described above.

Format

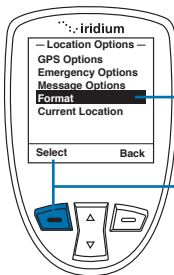

The **format** of your GPS location information can be modified.

The handset provides four (4) options for position:

- Decimal degrees
- Deg Min Sec (default setting)
- UTM
- U.S. National Grid

Position Format

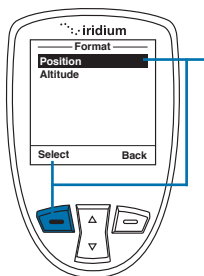

From the **Format** screen, to modify the setting for **position** format, press the **left soft key**, labeled **Select**.

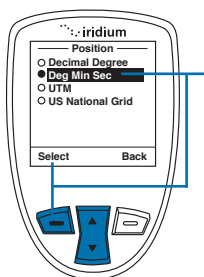

From the **Position** screen, to modify the setting for **position format**, use the **2-way Navi-Key** to highlight and the preferred format and then use the **left option key**, labeled **Select**.

Altitude Format

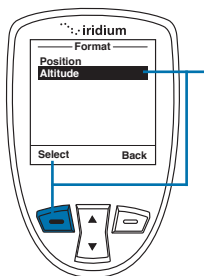

From the **Format** screen, to modify the setting for **Altitude format**, press the **left soft key**, labeled **Select**.

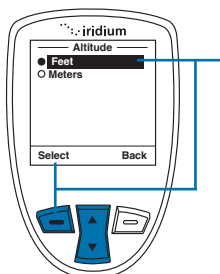

From the **Altitude** screen, to modify the setting for **Altitude format**, use the **2-way Navi-Key** to highlight and the preferred format and then use the **left option key**, labeled **Select**.

Current Location

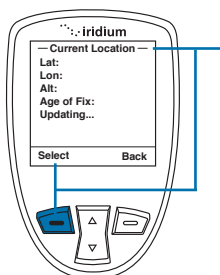

This screen is reached via the **Location Options** menu or by pressing the side **Convenience Key** which is programmed to pull up **Current Location** (to modify this setting, see Chapter 13). When **Current Location** is displayed:

- If GPS is enabled, the stored location fix will be displayed immediately (the position will be left blank if no stored position is available).
- If GPS and the GPS Settings Lock are disabled, you will be asked if you want to enable GPS; if so, the screen will be loaded with blank position data and with the message "Acquiring location" in place of "Age of fix".
- If you choose not to enable GPS, or if GPS is disabled and the **GPS Settings Lock** is on, then a "No location information available" message will be displayed temporarily.

If location is available, it will be displayed in the configured format including Latitude, Longitude, Altitude, Age of fix, and number of GPS satellites. The screen will update

automatically as frequently as you designated setting.

From this screen, you have the option to **Share your location** with other people by sending it in a message. To **Share**, press the **left option key**, labeled **Share**.

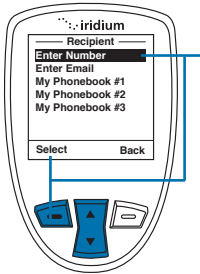

If **Share** is selected, the **Share Location Options** will appear. The available options are:

- **Quick GPS** – to send your location to your preconfigured list of up to five (5) contacts
- **New message** – to append your location to a new message, allowing you to add additional text and then address the message to a new or existing contact.

To **Share** your location, use the **2-way Navi-key** to select your desired Share method and press the **left option key**, labeled **Select**.

Online Portal Integration with 3rd Parties

Your Iridium Extreme™ also supports integration with 3rd party online portals using short burst data (SBD). These 3rd party online portals provide the ability to track your phone's location online, see location history, two-way message, set-up geofences, and coordinate scheduled check-ins. This capability is helpful if you are managing a fleet of phones and need to monitor workflow and/or safety with a solution that provides more robust capabilities than standard messaging. For more information about 3rd party online portal integration, contact your service provider.

15: Using the Security Menu

Important: Do not change the PIN/PUK/SIM settings unless you have your original settings available. Your phone and/or SIM card may be disabled if you don't know the correct code and enter it incorrectly three times. If a PIN becomes blocked, you must enter a Personal Unblocking Key (PUK) to restore the SIM to service which is obtained from your service provider.

Locating the Security Menu

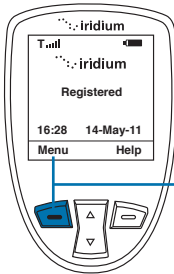

Starting from the **Main Screen**:

1. Press the **left soft key**, labeled **Menu**.

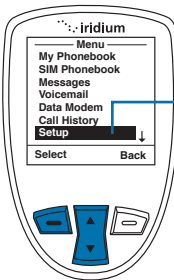

2. The **Main Menu** is displayed. Use the **2-way Navi-key** to scroll until **Security** is highlighted.

Note: All instructions for the **Security** menu start from the **Main Menu** as shown.

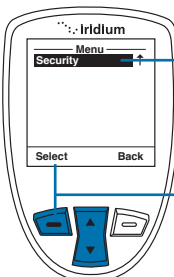

Note: Scroll one down from **Setup** to view the **Security** option.

3. Press the **left soft key**, labeled **Select**.

About the Security Menu

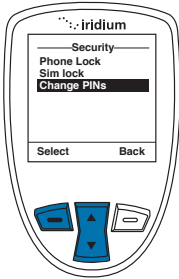

You can perform the following functions using the **Security** menu:

- Lock and unlock the phone
- Enable and disable the SIM lock
- Change PIN and block PIN codes

Locking and Unlocking Your Phone

This capability helps prevent unwanted use of your phone.

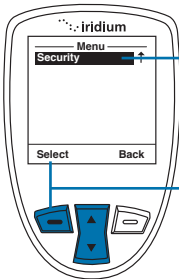

Starting from the **Main Menu**:

1. Use the **2-way Navi-key** to scroll until **Security** is highlighted.

Note: Scroll one down from **Setup** to view the **Security** option.

2. Press the **left soft key**, labeled **Select**.

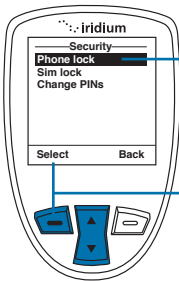

3. The **Phone lock** option is highlighted. If not, use the **2-way Navi-key** to scroll until it is.

4. Press the **left soft key**, labeled **Select**.

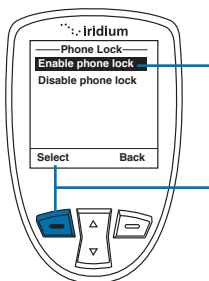

5. The **Enable phone lock** option is highlighted. If not, use the **2-way Navi-key** to scroll until it is.

6. Press the **left soft key**, labeled **Select**.

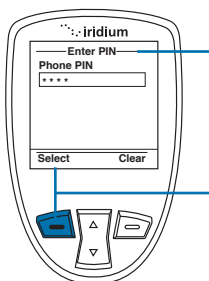

7. The **Enter PIN** screen appears. Using the keypad enter the PIN number.

8. Press the **left soft key**, labeled **Select**.

The Phone lock capability takes effect when you turn OFF your Iridium Extreme™. Each time you restart the phone, you are prompted to enter your Phone PIN. Once you do, the phone is fully operational.

Enable or Disable the SIM lock

When you activate the SIM lock capability, your phone requests your SIM PIN whenever your phone is powered on. To change this setting, you need to enter the SIM PIN code that your service provider gave you.

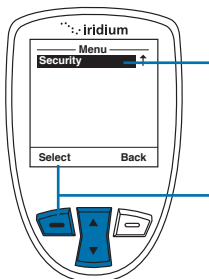

Starting from the **Main Menu**:

1. Use the **2-way Navi-key** to scroll until **Security** is highlighted.

Note: Scroll one down from **Setup** to view the **Security** option.

2. Press the **left soft key**, labeled **Select**.

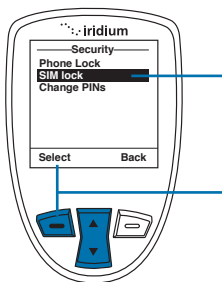

3. Use the 2-way **Navi-key** to scroll until **SIM lock** is highlighted.

4. Press the **left soft key**, labeled **Select**.

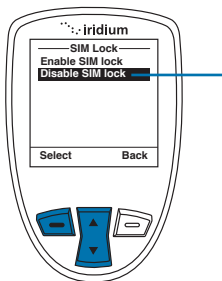

5. Use the **2-way Navi-key** until the action you prefer is highlighted.

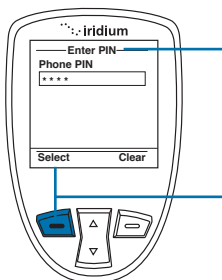

6. The **Enter PIN** screen appears. Using the keypad enter the PIN number.

7. Press the **left soft key**, labeled **Select**.

The message **SIM lock disabled** briefly appears, then returns to the SIM Lock menu.

Using the Change PIN Menu

Change the Phone PIN Code

This capability allows you to modify the default PIN associated with your phone.

Starting from the **Main Menu**:

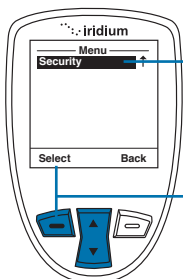

1. Use the **2-way Navi-key** to scroll until **Security** is highlighted.

Note: Scroll one down from **Setup** to view the **Security** option.

2. Press the **left soft key**, labeled **Select**.

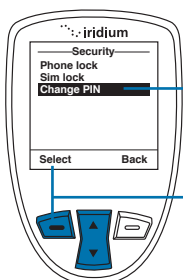

3. Use the 2-way **Navi-key** to scroll until **Change PIN** is highlighted.

4. Press the **left soft key**, labeled **Select**.

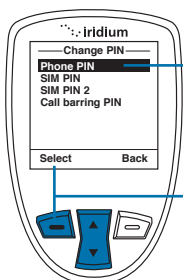

5. The **Change PIN** menu appears. **Phone PIN** is highlighted.

6. Press the **left soft key**, labeled **Select**.

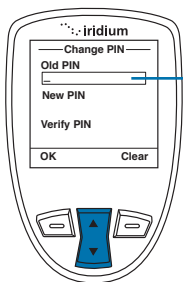

7. Enter your current PIN in the **Old PIN** field (the default PIN is 1234). Use the **2-way Navi-key** to move to the next field and enter your new PIN into the **New PIN** field. Move to the **Verify PIN** field and enter the new PIN again.

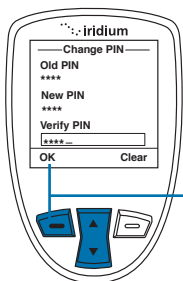

8. When all fields are complete, press the **left soft key**, labeled **OK**.

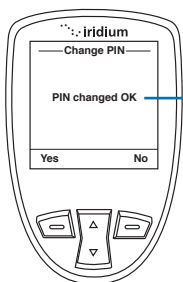

9. The screen displays **PIN changed OK** then returns to the **Change PIN** menu.

Change the SIM PIN Code

This capability allows you to modify the default PIN associated with your SIM card.

Starting from the **Main Menu**:

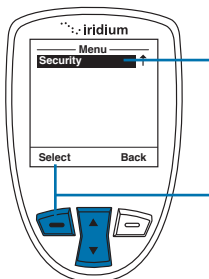

1. Use the **2-way Navi-key** to scroll until **Security** is highlighted.

Note: Scroll one down from **Setup** to view the **Security** option.

2. Press the **left soft key**, labeled **Select**.

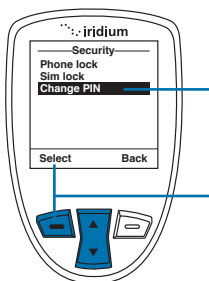

3. Use the **2-way Navi-key** to scroll until **Change PIN** is highlighted.

4. Press the **left soft key**, labeled **Select**.

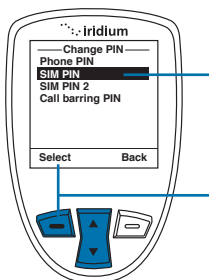

5. Use the **2-way Navi-key** to scroll until **SIM PIN** is highlighted.

6. Press the **left soft key**, labeled **Select**.

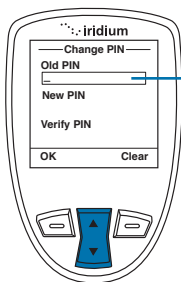

7. Enter your current PIN in the **Old PIN** field (the default PIN is 1111). Use the **2-way Navi-key** to move to the next field and enter your new PIN into the **New PIN** field. Move to the **Verify PIN** field and enter the new PIN again.

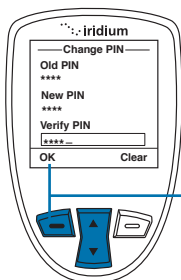

8. When all fields are complete, press the **left soft key**, labeled **OK**.

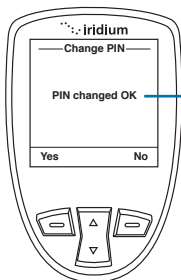

9. The screen displays **PIN changed OK** then returns to the **Change PIN** menu.

Change the SIM Card PIN2 Code

Your SIM card PIN2 code is used to access fixed dialing settings. This four-to-eight-digit code is issued to you when you subscribe to the capability.

Starting from the **Main Menu**:

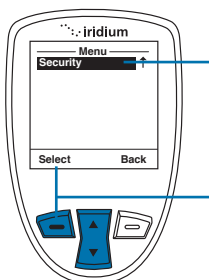

1. Use the **2-way Navi-key** to scroll until **Security** is highlighted.

Note: Scroll one down from **Setup** to view the **Security** option.

2. Press the **left soft key**, labeled **Select**.

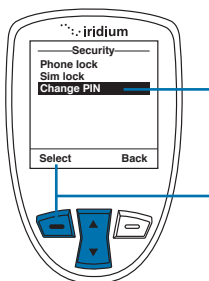

3. Use the **2-way Navi-key** to scroll until **Change PIN** is highlighted.

4. Press the **left soft key**, labeled **Select**.

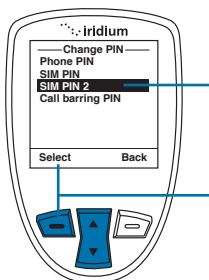

5. Use the **2-way Navi-key** to scroll until **SIM PIN 2** is highlighted.

6. Press the **left soft key**, labeled **Select**.

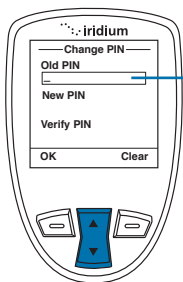

7. Enter your current PIN in the **Old PIN** field. Use the **2-way Navi-key** to move to the next field and enter your new PIN into the **New PIN** field. Move to the **Verify PIN** field and enter the new PIN again.

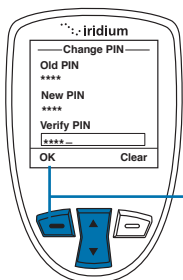

8. When all fields are complete, press the **left soft key**, labeled **OK**.

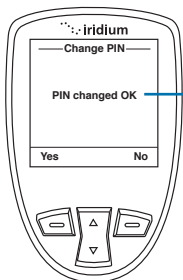

9. The screen displays **PIN changed OK** then returns to the **Change PIN** menu.

Call Barring PIN

Call Barring may be enabled for incoming and/or outgoing calls in the **Setup, Call Options** menu. When you enable Call Barring, you are prompted for a PIN. The Call Barring PIN may be changed as follows.

Starting from the **Main Menu**:

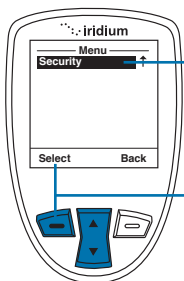

1. Use the **2-way Navi-key** to scroll until **Security** is highlighted.

Note: Scroll one down from **Setup** to view the **Security** option.

2. Press the **left soft key**, labeled **Select**.

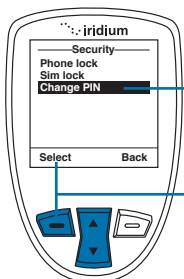

3. Use the 2-way **Navi-key** to scroll until **Change PIN** is highlighted.

4. Press the **left soft key**, labeled **Select**.

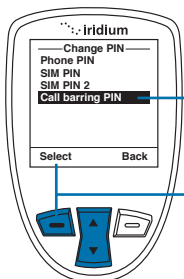

5. Use the **2-way Navi-key** to scroll until **Call barring PIN** is highlighted.

6. Press the **left soft key**, labeled **Select**.

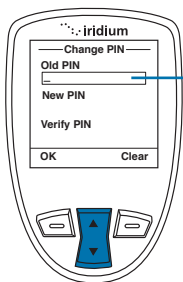

7. Enter your current PIN in the **Old PIN** field. Use the **2-way Navi-key** to move to the next field and enter your new PIN into the **New PIN** field. Move to the **Verify PIN** field and enter the new PIN again.

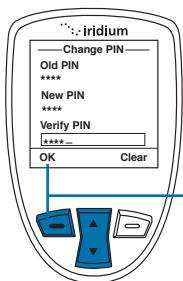

8. When all fields are complete, press the **left soft key**, labeled **OK**.

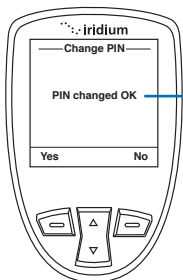

9. The screen displays **PIN changed OK** then returns to the **Change PIN** menu.

16: Troubleshooting

Problem	Solution
Phone won't power on.	<ul style="list-style-type: none">• Did you press and hold the power button for a minimum of three seconds to turn the phone's power on?• Check the battery. Is it charged, properly fitted, and are the contacts clean and dry?
You can't make calls.	<ul style="list-style-type: none">• Check the antenna. Is it fully extended and correctly angled? Do you have a clear unobstructed view of the sky?• Did you enter the number in international format? All calls made from the Iridium satellite system must be in international format. See "Placing a Call" on page 32.• Check the signal strength indicator. If the signal is weak, ensure that you have a clear line of sight to the sky and there are no buildings, trees, or other objects interfering.• Is Restricted displayed? Check the Call Barring setting.• Has a new SIM card been inserted? Check that no new restrictions have been imposed.• Check to see if your fixed dialing list is enabled. If so, you can only make calls to numbers or prefixes that are on the list.
You can't receive calls.	<ul style="list-style-type: none">• Check to see that your phone is powered on.• Check the antenna. Is it fully extended and correctly angled? Do you have a clear unobstructed view of the sky?• Check the signal strength indicator. If the signal is weak, ensure that you have a clear line of sight to the sky and there are no buildings, trees, or other objects around.• Check the Call Forwarding and Call Barring settings.• Check the Ringer setting. If it is off, there is no audible ringer.• Check to see if your fixed dialing list is enabled.

You can't make international calls.	<ul style="list-style-type: none"> • Have you included the relevant codes? Enter 00 or + followed by the appropriate country code and the phone number.
Your phone will not unlock.	<ul style="list-style-type: none"> • Have you inserted a new SIM card? Enter the new PIN code the default PIN is 1111). • Enter the default phone unlock code: 1234 • Have you forgotten the unlock code?
Your PIN is blocked.	<ul style="list-style-type: none"> • Enter the PIN unblocking code or contact your service provider. See "Using the Security Menu" on page 179 for more information.
Your PIN2 is blocked.	<ul style="list-style-type: none"> • Enter the PIN2 unblocking code or contact your service provider. See "Using the Security Menu" on page 179 for more information.
Your SIM card will not work.	<ul style="list-style-type: none"> • Is the SIM card inserted the correct way? • Is the card visibly damaged or scratched? Return the card to your service provider. • Check the SIM and card contacts. If they are dirty, clean them with an antistatic cloth.
You can't cancel Call Forwarding or Call Barring .	Wait until you are in an area with good network coverage and try again.
The message indicator is flashing.	There is not enough memory available to store another message. Use the messages menu to delete one or more messages.
The battery won't charge.	<ul style="list-style-type: none"> • Check the charger. Is it properly connected? Are its contacts clean and dry? • Check the battery contacts. Are they clean and dry? • Check the battery temperature. If it is warm, let it cool before charging. • Is it an old battery? Battery performance declines after several years of use. Replace the battery. • Make sure you have an Iridium approved battery installed. If you see ? on the display near the charging icon, you cannot charge this battery.

<p>The battery drains faster than normal.</p>	<ul style="list-style-type: none"> • Are you in an area of variable coverage? This uses extra battery power. • Is your antenna fully extended and correctly angled? Do you have a clear unobstructed view of the sky? This helps use less battery power. • Is it a new battery? A new battery needs two to three charge/discharge cycles to attain normal performance • Is it an old battery? Battery performance declines after several years of use. Replace the battery. • Is it a battery that hasn't been completely discharged? Allow the battery to fully discharge (until the phone turns itself off) and then charge the battery overnight. • Are you using your phone in extreme temperatures? At extreme hot or cold temperatures, battery performance is significantly reduced.
<p>You find your phone becoming warm during use.</p>	<p>You may notice this during long calls or during charging. The heat is produced by the electronic components within your phone and is quite normal.</p>
<p>Phone is not responding to user controls including the power keys.</p>	<p>Remove the battery from the phone and then reattach it to cycle power and reset.</p>
<p>Your SIM card is inserted in the phone but the display says:</p> <p>Check Card or Insert Card or Blocked</p>	<p>Check Card or Insert Card</p> <p>Check that the SIM card has been inserted correctly. The contacts of the SIM card may be dirty. Turn the phone off, remove the SIM card and rub the contacts with a clean cloth. Replace the card in the phone.</p> <p>Blocked</p> <p>Enter the PIN unblocking key or contact your service provider. See "Call Barring PIN" on page 189 for additional information.</p>

<p>Your phone is displaying an unknown foreign language and you would like to restore it to its original setting.</p>	<ul style="list-style-type: none"> • Power on the phone. • Power on the phone. Press left soft key for menu. • Power on the phone. Press down six times for Setup, then left soft key for Select. • Power on the phone. Press down three times for Languages, then left soft key for Select. • Power on the phone. Press left soft key for Select.
<p>Phone states “Searching for Network”</p>	<ul style="list-style-type: none"> • Ensure you are in an area with an open view of the sky • Extend the antenna and point upright towards the sky directly above in order to receive a signal • If your phone was powered on inside of a building or area with an obstructed view of the sky just prior to attempting a call outside, the phone may be temporarily in a power saving mode to conserve battery life. You may either wait for it to automatically exit the power saving mode within a minute or two on its scheduled interval or just simply turn off your phone and turn it on again to accelerate the registration process.

17: Certification and Compliance Information

Export Compliance

The Iridium Extreme™ is controlled by the export laws and regulations of the United States of America. The U.S. Government may restrict the export or re-export of this phone to certain individuals and/or destinations. For further information, contact the U.S. Department of Commerce, Bureau of Industry and Security or visit www.bis.doc.gov

Standards Compliance Information

The Iridium Extreme™ is designed to comply with the standards for Radio Emissions Compliance, Electromagnetic Compatibility, and AC Safety in the United States, European Union, Canada and Mexico.

FCC Compliance

The Iridium Extreme™ is certified under 47 CFR Part 25 as FCC ID: Q639575. It also complies with Part 15 of the FCC Regulations. Operation is subject to the condition that this device does not cause harmful interference. Any unauthorized antennas, modifications or attachments could damage the Iridium Extreme™ and may violate FCC regulations and void your authority to operate the phone.

EU Regulatory Conformity

The Iridium Extreme™ complies with the essential requirements and other relevant provisions of the EU Directive 1999/5/EC.

Canada Regulatory Conformity

The Iridium Extreme™ complies with Industry Canada RSS-170. Certification Number IC 4629A-9575.

18: Limited Warranty, Product and Satellite Service Terms, Warranty Support, and Software License

This Limited Warranty applies only to the Iridium branded Iridium Extreme™ (including hardware, software and firmware but excluding leather case) and the Accessories listed in Chapter 3 of this User Manual (collectively, “Product”) sold by Iridium or its authorized resellers and distributors (collectively, “Service Providers”). This Limited Warranty extends only to the first purchaser of the Product and is not assignable or transferable.

Subject to the Exclusions contained below, Iridium warrants to you that the Product will be free from defects in materials and workmanship under normal usage for a period of one year from your date of purchase. You are required to provide proof of purchase as a condition of receiving warranty service as more fully described in “Warranty Claim Process” on page 202.

Any replacement products or parts may contain new and used materials equivalent to new in performance and reliability. Any replacement product or part will also have functionality at least equal to that of the product or part being replaced. Replacement products and parts are warranted to be free from defects in material or workmanship under normal usage for the remainder of the applicable warranty period of the original Product for which a replacement product or part is provided under this Limited Warranty. A returned Product for which a replacement has been provided shall become Iridium’s property.

If Iridium receives, during the warranty period and in accordance with the instructions set out in this Limited Warranty, notice of a defect in the Product covered by this Limited Warranty, Iridium will repair or replace the Product or refund the purchase price of the Product, at Iridium’s sole option. Iridium shall have no obligation to repair, replace, or refund unless the defective Product is returned in accordance with the instructions set out in this Limited Warranty and within the warranty period.

IRIDIUM DOES AND MAY CONTINUE, AT ITS SOLE DISCRETION, TO SUBCONTRACT TO AND ENGAGE A THIRD PARTY TO PROVIDE THE WARRANTY SERVICES PROVIDED FOR IN THIS USER MANUAL.

Exclusions

This Limited Warranty does not apply in the following circumstances:

Normal wear and tear. Periodic maintenance, repair or replacement of parts due to normal wear and tear are excluded from coverage.

Batteries. Only batteries whose fully charged capacity falls below 80% of rated capacity and batteries that leak are covered by this Limited Warranty. Batteries that are charged by other than an Iridium-approved battery charger; having seals that are broken or show evidence of tampering; are used in equipment other than the Product; or are charged and stored at temperatures greater than 60 degrees centigrade, are not covered by this Limited Warranty.

Abuse and Misuse. Defects or damage that result from improper operation or storage, misuse or abuse, accident or neglect; exposure to or contact with liquid, water, rain, extreme humidity or heavy perspiration, sand, dirt or the like, extreme heat or spills of food; use of the Product for abnormal purposes; stretching coil cords or breaking coil cord modular tabs; breakage or damage to antennas or scratches or other damage to plastic surfaces or other externally exposed parts caused by your use; or other acts which are not the fault of Iridium, are excluded from coverage.

Use of Non-Iridium Products and Accessories. Defects or damage that result from the use of non-Iridium branded products (other than the antenna supplied with your Product), accessories or software or other ancillary or peripheral equipment are excluded from coverage.

Unauthorized Service or Modifications. Defects or damage resulting from any service, testing, adjustment, integration, installation, operation, maintenance, service, alteration, modification or integration with any non-Iridium product in any manner other than in accordance with Product user documentation and instructions and/or by someone other than Iridium or a Service Provider are excluded from coverage.

Altered Products. Products that have been tampered with, altered, have non-Iridium housings or parts, or have had the serial numbers or date tags removed, altered or obliterated are excluded from coverage.

Communication Services. Defects, damages or failure of the Product due to any non-Iridium communication service or signal or use of a non-Iridium branded communication service or signal are excluded from coverage.

Software Embodied in Physical Media. No warranty is made that any software will meet your requirements or will work in combination with any hardware or software applications provided by third parties, that the

operation of the software will be uninterrupted or error free, or that all defects in the software will be corrected.

Privacy and Data Security. Privacy and data security are important to everyone. Some features of your Product may affect your privacy or data security. Therefore, it is important to monitor access to your Product and not to leave it where others might have unmonitored access. Lock your satellite phone's keypad when not in use. Erase all personal information or data before disposing of the satellite phone or recycling it. See Chapter 8 of this User Manual for instructions on how to delete all personal information. The satellite phone uses network-based positioning technology, which may be used to obtain a user's approximate location and thereby affect a user's privacy.

Limitations of Warranty/Local Laws

IRIDIUM MAKES NO REPRESENTATIONS, GUARANTEES, CONDITIONS OR WARRANTIES, EITHER EXPRESS OR IMPLIED, INCLUDING WITHOUT LIMITATION, ANY IMPLIED REPRESENTATIONS, GUARANTEES, CONDITIONS OR WARRANTIES OF MERCHANTABILITY AND FITNESS FOR A PARTICULAR PURPOSE, NON-INFRINGEMENT, SATISFACTORY QUALITY, NON-INTERFERENCE, ACCURACY OF INFORMATIONAL CONTENT, OR ARISING FROM A COURSE OF DEALING, LAW, USAGE, OR TRADE PRACTICE, USE, OR RELATED TO THE PERFORMANCE OR NONPERFORMANCE OF ANY PRODUCTS, ACCESSORIES, FACILITIES OR SERVICES OR USER INFORMATION, EXCEPT AS EXPRESSLY STATED IN THIS USER MANUAL. ANY OTHER STANDARDS OF PERFORMANCE, GUARANTEES, CONDITIONS AND WARRANTIES ARE HEREBY EXPRESSLY EXCLUDED AND DISCLAIMED TO THE FULLEST EXTENT PERMITTED BY LAW. THIS DISCLAIMER AND EXCLUSION SHALL APPLY EVEN IF THE EXPRESS LIMITED WARRANTY CONTAINED HEREIN FAILS OF ITS ESSENTIAL PURPOSE. FURTHER, THIS LIMITED WARRANTY COVERS THE PRODUCT ONLY, AND NO WARRANTY IS MADE AS TO USER INFORMATION AND/OR COVERAGE, AVAILABILITY OR GRADE OF SERVICE PROVIDED BY IRIDIUM SEPARATELY FOR IRIDIUM SATELLITE SERVICES.

This Product is covered by a U.S.A. warranty. This Limited Warranty is applicable in all countries and is enforceable in any country or region where Iridium or its Service Provider offer warranty service for the Product. Outside of the U.S.A., any different warranty terms, liabilities and/or legal requirements of the country in which the Product is sold are specifically disclaimed by Iridium. Warranty service availability and response times may vary from country to country and may be subject to registration requirements in the country of purchase. Your Iridium Service Provider can provide details.

This Limited Warranty gives you specific legal rights. You may also have other rights that may vary from state to state/country to country. Some states/countries do not allow or acknowledge the existence, limitation or exclusion of incidental or consequential damages, or limitation on the length of an implied warranty, so some limitations or exclusions of this Limited Warranty may not apply to you. You are advised to consult applicable state/country laws for a full determination of your rights.

Conditions of Use and Limitations of Liability.

This Limited Warranty is your sole and exclusive remedy. These terms and conditions supersede any prior agreements or representations, including those made in Iridium sales literature or advice given to you by or on behalf of Iridium in connection with your purchase.

ANY IMPLIED WARRANTIES THAT MAY BE IMPOSED BY LAW, INCLUDING, WITHOUT LIMITATION, THE IMPLIED WARRANTIES OF MERCHANTABILITY AND FITNESS FOR A PARTICULAR PURPOSE, SHALL BE LIMITED TO THE DURATION OF THIS LIMITED WARRANTY. OTHERWISE THE REPAIR, REPLACEMENT, OR REFUND AS PROVIDED UNDER THIS EXPRESS LIMITED WARRANTY IS PROVIDED IN LIEU OF ALL OTHER WARRANTIES, EXPRESS OR IMPLIED. IN NO EVENT SHALL IRIDIUM BE LIABLE, WHETHER IN CONTRACT OR TORT OR ANY OTHER LEGAL THEORY, INCLUDING WITHOUT LIMITATION STRICT LIABILITY, GROSS NEGLIGENCE OR NEGLIGENCE, FOR ANY DAMAGES IN EXCESS OF THE PURCHASE PRICE OF THE PRODUCT AND/OR THE COST OF IRIDIUM SATELLITE SERVICES PROVIDED, INCLUDING ANY DIRECT, INDIRECT, INCIDENTAL, SPECIAL OR CONSEQUENTIAL DAMAGES OF ANY KIND, OR LOSS OF REVENUE OR PROFITS, LOSS OF BUSINESS, LOSS OF PRIVACY, LOSS OF USE, LOSS OF TIME OR INCONVENIENCE, LOSS OF INFORMATION OR DATA, SOFTWARE OR APPLICATIONS OR OTHER FINANCIAL LOSS CAUSED BY THE PRODUCT AND/OR THE IRIDIUM SATELLITE SERVICES, OR ARISING OUT OF OR IN CONNECTION WITH THE ABILITY OR INABILITY TO USE THE PRODUCT AND/OR THE IRIDIUM SATELLITE SERVICES TO THE FULLEST EXTENT THESE DAMAGES MAY BE DISCLAIMED BY LAW AND WHETHER ADVISED OF THE POSSIBILITIES OF SUCH DAMAGES. IRIDIUM IS NOT LIABLE FOR ANY CLAIM MADE BY A THIRD PARTY OR MADE BY YOU FOR A THIRD PARTY.

USERS OF THE IRIDIUM SATELLITE PHONE SERVICES AND RELATED EQUIPMENT, INCLUDING WITHOUT LIMITATION THOSE USING THE PHONE SERVICE AND THE PRODUCT IN ANY MANNER IN CONJUNCTION WITH EMERGENCY 911 (U.S.), EMERGENCY TRIPLE ZERO (000)/ 112 (AUSTRALIA) OR ANY OTHER DISTRESS CALLING OR EMERGENCY SERVICES, BOTH PUBLIC OR PRIVATELY OPERATED,

ACKNOWLEDGE AND AGREE AS A CONDITION OF THE PROVISION OF PHONE SERVICE AND PRODUCT BY IRIDIUM THAT THEY WILL MAKE NO CLAIM, WHETHER IN CONTRACT, TORT OR OTHERWISE, AGAINST IRIDIUM FOR BODILY INJURY, LOSS OF LIFE, DAMAGE TO PROPERTY OR FOR ANY OTHER LOSS WHATSOEVER, OR FOR SPECIAL, INCIDENTAL, INDIRECT, CONSEQUENTIAL OR PUNITIVE DAMAGES, BY REASON OF ANY UNAVAILABILITY, DELAY, FAULTINESS OR FAILURES OF THE IRIDIUM FACILITIES OR PHONE SERVICE OR EQUIPMENT OR FOR INACCURACIES OR FAILURES WITH REGARD TO ANY USER INFORMATION PROVIDED. THIS IS A WAIVER AND RELEASE AND DISCLAIMER OF LIABILITY TO THE FULLEST EXTENT PERMITTED BY APPLICABLE LAW AND APPLIES REGARDLESS OF THE CAUSE OF ANY LIABILITY, INCLUDING WITHOUT LIMITATIONS, TO WRONGFUL CONDUCT, OMISSION OR FAULT OF EMPLOYEES OR AGENTS OF IRIDIUM.

By your use of the Product and Iridium Satellite Services you consent to Iridium's disclosure of user information, including but not limited to name, address, telephone number and location information, including, where available, the geographic coordinates of equipment, to governmental and quasi-governmental agencies where Iridium deems it necessary in its sole discretion to respond to an exigent circumstance. These governmental and quasi-governmental agencies shall be deemed "users" for all purposes of this Limited Warranty.

You are permitted to use the Product only as described and specified in this Limited Warranty. By using the Product, you are indicating that you agree to comply with the terms of this Limited Warranty, including this section describing permitted use of the Product (the "Conditions of Use"). If you fail to comply with this Limited Warranty and the Conditions of Use, Iridium may void certain protections offered under the Limited Warranty and Iridium reserves the right to terminate your right to use the Product on the Iridium system. If you do not accept the terms of this Limited Warranty, do not use the Product on the Iridium system.

You are permitted to use the Product only in connection with service on the Iridium system using airtime purchased from your Service Provider. You are required to comply with this Limited Warranty and the Conditions of Use and Limitations of Liability, as well as all terms and conditions that are provided separately by your Service Provider, as such terms and conditions may change from time to time. Iridium or your Service Provider may also establish additional terms and conditions from time to time. In the event any Iridium term or condition conflicts with any Service Provider term or condition, the Iridium term or condition shall govern. Service provider will be provided with notice of any new terms and conditions or any changes in these terms and conditions. All terms and conditions will

be effective as of your receipt of the notices of new or modified terms and conditions, and your continued use of the Product after such receipt shall constitute your acceptance of such new or modified terms.

You may not use the Product in connection with any third-party devices, including but not limited to computers, cameras, batteries, GPS devices, recorders or other devices which alter the information sent or received by the Product, except to the extent that Iridium has tested those devices and confirmed that their use will have no adverse effect on the Iridium system. All devices approved by Iridium will be advertised and labeled as being approved by Iridium and you may use only “Iridium-Approved Devices” with this Product and with the Iridium system.

You may not modify the Product or any component of the Product. You may not reverse-engineer, or attempt to reverse-engineer, the Product, any component of any Product or the manner in which the Product connects to, sends information to, receives information from, or otherwise interacts with the Iridium system.

You are required to comply with all applicable laws and regulations in your use of the Product. To the extent that you: (i) violate this Limited Warranty, the terms and conditions applicable to the Iridium system or other agreements between you and Iridium, or between you and your Service Provider; (ii) utilize a product other than an Iridium-Approved Device on the Iridium system; (iii) modify the Product or any Product component, reverse-engineer the Product or any Product component or attempt to do so; or (iv) violate any applicable laws or regulations (collectively “Unauthorized Use”), you agree to defend, indemnify and hold Iridium and your Service Provider harmless with respect to any claims or actions by governmental entities or other third parties related to your Unauthorized Use and to pay all costs, damages, fines and other amounts incurred by us, or on our behalf, in the defense of any such claims or actions. Further, we specifically disallow any liability and will not credit back airtime charges related to any Unauthorized Use.

In addition to Iridium’s express reservation of other remedies available to us, we reserve the right to discontinue providing Iridium Satellite Services to you and/or to disable your Product’s access to the Iridium system. If Iridium reasonably believes that you are engaged in any Unauthorized Use, we may seek equitable relief to prevent such Unauthorized Use without having to wait to see if damage to the Iridium system occurs.

Warranty Claim Process

Should your Product require service within the warranty period or for warranty questions, repairs or for the return of the Product, **please contact your Service Provider or any other Service Provider in your**

country. Do not contact Iridium. For warranty claims, you will be required to provide the following proof of purchase documentation: your dated bill of sale or delivery receipt (including your name, address and telephone number; the name and address of the Service Provider who sold you the Product; the model number and International Mobile Identification Number (IMEI); and the sale price of the Product), together with a written description of the problem. You are responsible for shipping the Product to the authorized warranty service center designated by your Service Provider with freight and insurance prepaid. Product that is repaired or replaced under this Limited Warranty shall be returned to you at no expense for the freight and insurance, and at your expense for any applicable duties or other charges.

Refer to www.iridium.com for a list of Service Providers or contact your Service Provider for warranty information.

SOFTWARE LICENSE

The following terms govern your access and use of the Iridium or Iridium-supplied software (“Software”) contained on the Product you purchased.

License. Conditioned upon compliance with the terms and conditions of this Limited Warranty, Iridium grants to you a nonexclusive and nontransferable license to use for your internal purposes the Software and the Documentation. “Documentation” means written information (whether contained in user or technical manuals, training materials, specifications or otherwise) pertaining to the Software and made available by Iridium with the Software in any manner. You shall use the Software solely as embedded in (or, if downloaded, as provided via download), for execution on, and for communication via the Iridium system.

No other licenses are granted by implication, estoppel or otherwise.

General Limitations. This is a license, not a transfer of title, to the Software and Documentation, and Iridium retains ownership of all copies of the Software and Documentation. You acknowledge that the Software and Documentation contain trade secrets of Iridium or its suppliers or licensors, including but not limited to the specific internal design and structure of individual programs and associated interface information. Except as otherwise expressly provided, you shall have no right, and you specifically agree not to:

- (i) transfer, assign or sublicense your license rights to any other person or entity (other than in compliance with any Iridium relicensing/transfer policy then in force), or use the Software on unauthorized

or secondhand Iridium equipment, and you acknowledge that any attempted transfer, assignment, sublicense or use shall be void;

- (ii) make error corrections to or otherwise modify or adapt the Software or create derivative works based upon the Software, or permit third parties to do the same;
- (iii) reverse engineer or decompile, decrypt, disassemble or otherwise reduce the Software to human-readable form, except to the extent otherwise expressly permitted under applicable law notwithstanding this restriction;
- (iv) use or permit the Software to be on a service bureau or time sharing basis or otherwise, without the express written authorization of Iridium; or
- (v) disclose, provide, or otherwise make available trade secrets contained within the Software and Documentation in any form to any third party without the prior written consent of Iridium. You shall implement reasonable security measures to protect such trade secrets.

To the extent required by law, and at your written request, Iridium shall provide you with the interface information needed to achieve interoperability between the Software and another independently created program, on payment of Iridium's applicable fee, if any. You shall observe strict obligations of confidentiality with respect to such information and shall use such information in compliance with any applicable terms and conditions upon which Iridium makes such information available.

Software, Upgrades and Additional Copies. "Software" shall include computer programs, including firmware, as provided to you by Iridium or a Service Provider, and any upgrades, updates, bug fixes or modified versions thereto (collectively, "Upgrades") or backup copies of any of the foregoing. NOTWITHSTANDING ANY OTHER PROVISION OF THE AGREEMENT: (1) UNLESS AUTHORIZED BY IRIDIUM, YOU HAVE NO LICENSE OR RIGHT TO MAKE OR USE ANY ADDITIONAL COPIES OR UPGRADES. IRIDIUM MAY MAKE SOFTWARE AVAILABLE BASED ON ADDITIONAL TERMS; (2) USE OF UPGRADES IS LIMITED TO IRIDIUM EQUIPMENT FOR WHICH YOU ARE THE ORIGINAL END USER PURCHASER OR OTHERWISE HOLD A VALID LICENSE TO USE THE SOFTWARE WHICH IS BEING UPGRADED; AND (3) THE MAKING AND USE OF ADDITIONAL COPIES IS LIMITED TO NECESSARY BACKUP PURPOSES ONLY.

Proprietary Notices. You agree to maintain and reproduce all copyright and other proprietary notices on all copies, in any form, of the Software in the same form and manner that such copyright and other proprietary notices are included on the Software. Except as expressly authorized, you

shall not make any copies or duplicates of any Software without the prior written permission of Iridium.

Term and Termination. The license granted herein shall remain effective until terminated. You may terminate the license at any time by destroying all copies of Software and any Documentation. Your rights under the license will terminate immediately without notice from Iridium if you fail to comply with any provision of the license and Limited Warranty. Upon termination, you shall destroy all copies of Software and Documentation in your possession or control. All of your confidentiality obligations and all limitations of liability and disclaimers and restrictions of warranty shall survive termination.

Export, Re-Export, Transfer and Use Controls. The Software, Documentation and technology or direct products thereof (hereafter referred to as Software and Technology), supplied by Iridium are subject to export controls under the laws and regulations of the United States (U.S.). You shall comply with such laws and regulations governing export, re-export, transfer and use of Iridium Software and Technology and will obtain all required U.S. and local authorizations, permits, or licenses. Iridium and you each agree to provide the other information, support documents, and assistance as may reasonably be required by the other in connection with securing authorizations or licenses.

U.S. Government End User Purchasers. The Software and Documentation qualify as “commercial items,” as that term is defined at Federal Acquisition Regulation (“FAR”) (48 C.F.R.) 2.101, consisting of “commercial computer software” and “commercial computer software documentation” as such terms are used in FAR 12.212. Consistent with FAR 12.212 and DoD FAR Supp. 227.7202-1 through 227.7202-4, and notwithstanding any other FAR or other contractual clause to the contrary in any agreement into which this Limited Warranty may be incorporated, you may provide to Government end user or Government end user will acquire, as applicable, the Software and Documentation with only those rights set forth in this Limited Warranty. Use of either the Software or Documentation or both constitutes agreement by the Government that the Software and Documentation are “commercial computer software” and “commercial computer software documentation,” and constitutes acceptance of the rights and restrictions herein.



info@iridium.com | toll free: 1.866.947.4348 | phone: +1.480.752.5155

www.iridium.com

H3UG1101